

PVC & CPVC SCHEDULE 80 FITTINGS, UNIONS, TANK ADAPTERS, EXPANSION JOINTS & SADDLES

ASTM STANDARD DIMENSIONS

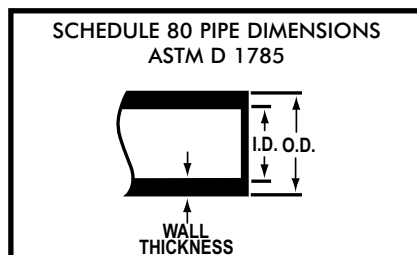

Nominal Pipe Size In.	Mean Outside Diameter In.	O. D. Tolerance In.	Minimum Wall Thickness In.
1/8	0.405	±0.004	0.095
1/4	0.540	±0.004	0.119
3/8	0.675	±0.004	0.126
1/2	0.840	±0.004	0.147
3/4	1.050	±0.004	0.154
1	1.315	±0.005	0.179
1-1/4	1.660	±0.005	0.191
1-1/2	1.900	±0.006	0.200
2	2.375	±0.006	0.218
2-1/2	2.875	±0.007	0.276
3	3.500	±0.008	0.300
4	4.500	±0.009	0.337
5	5.563	±0.010	0.375
6	6.625	±0.011	0.432
8	8.625	±0.015	0.500
10	10.750	±0.015	0.593
12	12.750	±0.015	0.687

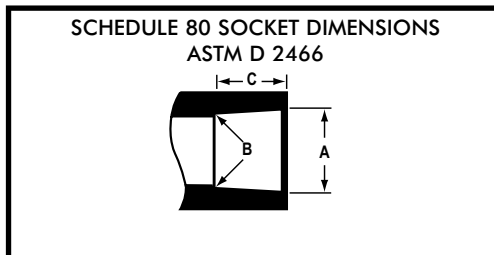

Nominal Size In.	Diameter			Socket Length Minimum C
	Entrance A	Bottom B	Tolerance A	
1/8	0.417	0.401	±0.004	0.500
1/4	0.552	0.536	±0.004	0.625
3/8	0.687	0.671	±0.004	0.750
1/2	0.848	0.836	±0.004	0.875
3/4	1.058	1.046	±0.004	1.000
1	1.325	1.310	±0.005	1.125
1-1/4	1.670	1.655	±0.005	1.250
1-1/2	1.912	1.894	±0.006	1.375
2	2.387	2.369	±0.006	1.500
2-1/2	2.889	2.868	±0.007	1.750
3	3.516	3.492	±0.008	1.875
4	4.518	4.491	±0.009	2.250
5	5.583	5.553	±0.010	2.625
6	6.647	6.614	±0.011	3.000
8	8.655	8.610	±0.015	4.000
10	10.780	10.735	±0.015	5.000
12	12.780	12.735	±0.015	6.000

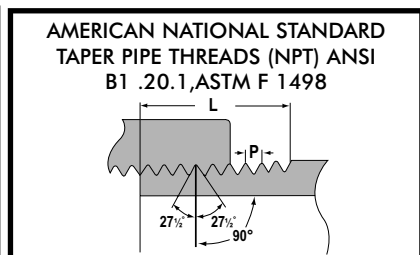

Nominal Size In.	Threads Per Inch	Effective Thread Length L	Pitch Of Thread P
1/8	27	0.2639	0.03704
1/4	18	0.4018	0.05556
3/8	18	0.4078	0.05556
1/2	14	0.5337	0.07143
3/4	14	0.5457	0.07143
1	11-1/2	0.6828	0.08696
1-1/4	11-1/2	0.7068	0.08696
1-1/2	11-1/2	0.7235	0.08696
2	11-1/2	0.7565	0.08696
2-1/2	8	1.1375	0.12500
3	8	1.2000	0.12500
4	8	1.3000	0.12500
5	8	1.4063	0.12500
6	8	1.5125	0.12500
8	8	1.7125	0.12500

STANDARD COMPARISONS

SPEARS® IPS-to-Metric transition unions are listed by nominal size. The chart below compares nominal and actual* pipe O.D. for each size according to the designated standard.

JIS K6741 (mm)		DIN 8062 (mm)		ASTM D1785 (in.)		NPT—ANSI B1.20.1** Tapered Thread		BSP—BS21, DIN 2999, ISO 7/1 Thread	
Nominal	Actual*	O.D.	Actual*	Nominal	Actual*	Designation	Threads/in.	Designation	Threads/25.4mm
16	22	20	20	1/2	.840	1/2	14	1/2	14
20	26	25	25	3/4	1.050	3/4	14	3/4	14
25	32	32	32	1	1.315	1	11.5	1	11
30	38	40	40	1-1/4	1.660	1-1/4	11.5	1-1/4	11
40	48	50	50	1-1/2	1.900	1-1/2	11.5	1-1/2	11
50	60	63	63	2	2.375	2	11.5	2	11
75	89	90	90	3	3.500	3	8	3	11
100	114	110	110	4	4.500	4	8	4	11

*Specified dimension, certain tolerances apply

**NPT and BSP have different thread angles and not compatible.

PVC & CPVC SCHEDULE 80 FITTINGS, UNIONS, TANK ADAPTERS, EXPANSION JOINTS & SADDLES

Injection Molded Dimensions References:

G = (LAYING LENGTH) intersection of center lines to bottom of socket/thread; 90° elbows, tees, crosses; ± 1/32 inch.
 H = intersection of center lines to face of fitting; 90° elbow tees, crosses; ± 1/32 inch.
 J = intersection of center lines to bottom of socket/thread; 45° elbows; ± 1/32 inch

L = overall length of fittings; ± 1/16 inch.
 H = outside diameter of socket/thread hub; ± 1/16 inch.
 N = socket bottom to socket bottom; couplings; ± 1/16 inch
 W = height of cap; ± 1/16 inch.

Fabricated Dimension References:

G = (LAYING LENGTH) intersection of center lines to bottom of socket/thread; 90° elbows, tees, crosses; ± 1/4 inch.
 H = intersection of center lines to face of fitting; 90° elbows, tees, crosses; ± 1/4 inch.; wyes ± 1/2 inch.
 J = intersection of center lines to bottom of socket/thread; 45° elbows; ± 1/4 inch.

L = overall length of fittings; ± 1/2 inch. wyes ± 1 inch.
 M = outside diameter of socket/thread hub; ± 1/4 inch.
 N = socket bottom to socket bottom; couplings; ± 1/2
 W = height of cap; ± 1/4 inch.

Typical Fabricated Dimension References

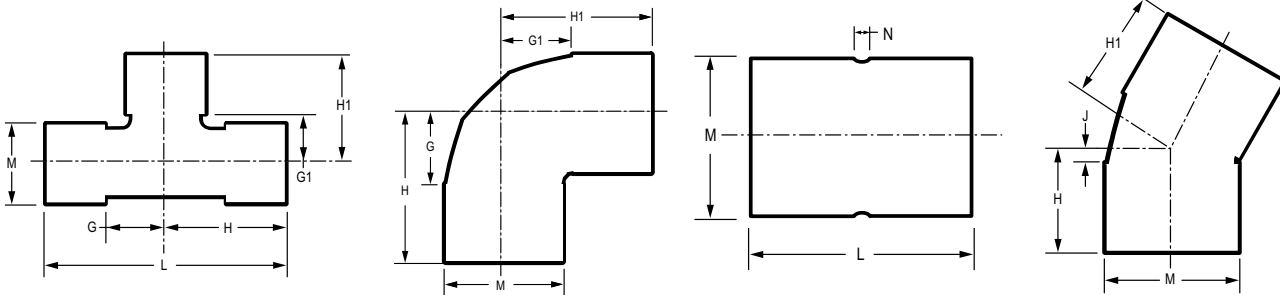

TEE

Soc x Soc x Soc

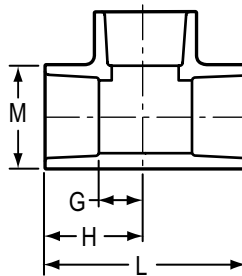

Part Number		Size	G	H	L	M	Approx. Wt. (Lbs.)	
PVC	CPVC						PVC	CPVC
801-002	801-002C	1/4	5/16	31/32	1-15/16	27/32	.04	.04
801-003	801-003C	3/8	15/32	1-1/4	2-1/2	31/32	.06	.06
801-005	801-005C	1/2	9/16	1-1/2	2-15/16	1-3/16	.10	.11
801-007	801-007C	3/4	11/16	1-11/16	3-3/8	1-13/32	.17	.17
801-010	801-010C	1	27/32	2	40	1-11/16	.28	.30
801-012	801-012C	1-1/4	7/8	2-1/8	4-14	2-3/32	.39	.43
801-015	801-015C	1-1/2	1-5/32	2-9/16	5-1/8	2-5/16	.55	.57
801-020	801-020C	2	1-7/16	2-15/16	5-7/8	2-7/8	.90	1.01
801-025	---	2-1/2	1-3/4	3-1/2	7	3-15/32	1.52	---
---	801-025C	2-1/2	1-9/16	3-3/8	6-23/32	3-5/8	---	1.71
801-030	801-030C	3	2-1/16	3-31/32	7-15/16	4-7/32	2.41	2.83
801-040	801-040C	4	2-5/8	4-7/8	9-3/4	5-1/4	3.43	4.15

PVC & CPVC SCHEDULE 80 FITTINGS, UNIONS, TANK ADAPTERS, EXPANSION JOINTS & SADDLES

TEE

Soc x Soc x Soc (continued)

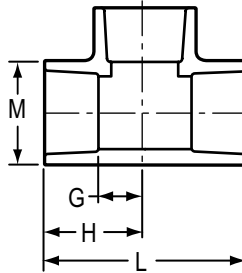

Part Number		Size	G	H	L	M	Approx. Wt. (Lbs.)	
PVC	CPVC						PVC	CPVC
801-050	801-050C	5	3-1/16	5-13/16	11-5/8	6-3/8	5.88	---
801-050F	801-050CF	5	7	10	20	6-5/16	13.26	18.38
801-060	801-060C	6	4-1/32	7-3/32	14-3/16	7-19/32	10.79	12.57
801-080	801-080C	8	4-13/16	8-13/16	17-5/8	9-11/16	21.03	21.24
801-080F	801-080CF	8	7-5/8	11-7/8	23-3/4	9-5/8	22.84	30.91
801-100	801-100C	10	5-3/4	10-13/16	21-5/8	1-19/32	37.89	40.50
801-100F	801-100CF	10	9	14-1/4	28-1/2	11-7/8	39.82	51.41
801-120	801-120C	12	6-15/16	12-15/16	25-7/8	14-1/4	54.45	62.00
801-120F	801-120CF	12	11-1/4	17-1/2	35	14-1/8	67.13	83.37
801-140F	801-140CF	14	11-1/4	18-1/4	36-1/2	15-1/2	103.37	108.34
801-160F	801-160CF	16	13	21	42	17-11/16	144.87	144.86
801-180F	801-180CF	18	13-3/4	22-3/4	45-1/2	19-7/8	182.75	198.00
801-200F	801-200CF	20	16-1/4	26-1/4	52-1/2	22-1/8	284.24	249.75
801-240F	801-240CF	24	17	29	58	26-1/2	335.00	460.00

REDUCING TEE

Soc x Soc x Soc

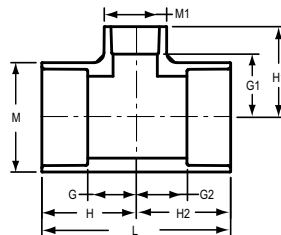

Part Number		Size	G	G1	G2	H	H1	H2	L	M	M1	Approx. Wt. (Lbs.)	
PVC	CPVC											PVC	CPVC
801-101	801-101C	3/4x3/4x1/2	19/32	23/32	19/32	1-19/32	1-19/32	1-19/32	3-3/16	1-13/32	1-3/16	.14	.15
801-130	801-130C	1x1x1/2	19/32	7/8	19/32	1-23/32	1-3/4	1-23/32	3-7/16	1-3/4	1-3/16	.20	.21
801-131	801-131C	1x1x3/4	23/32	27/32	23/32	1-27/32	1-27/32	1-27/32	3-11/16	1-11/16	1-3/8	.23	.24
801-157	---	1-1/4x1x3/4	11/16	1-1/16	5/8	1-15/16	2-1/16	1-7/8	3-13/16	2-1/8	1-7/16	.30	---
801-158	801-158C	1-1/4x1x1	13/32	15/16	13/32	2-1/8	1-31/32	1-15/16	4	2-1/16	1-11/16	.33	.34
801-159	801-159C	1-1/4x1x1-1/4	15/16	1-1/32	7/8	2-3/16	2-5/32	2-1/8	4-5/16	2-1/16	2-1/16	.39	.41
801-166 ¹	801-166C ¹	1-1/4x1-1/4x1/2	7/8	1-13/32	7/8	2-3/8	2-3/8	2-1/8	4-1/4	2-1/8	1-3/4	.42	.43

1: Outlet sized with bushing

PVC & CPVC SCHEDULE 80 FITTINGS, UNIONS, TANK ADAPTERS, EXPANSION JOINTS & SADDLES

REDUCING TEE (continued)

Soc x Soc x Soc

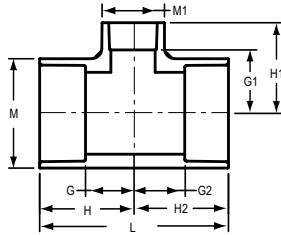

Part Number		Size	G	G1	G2	H	H1	H2	L	M	M1	Approx. Wt. (Lbs.)	
PVC	CPVC											PVC	CPVC
801-167 ¹	801-167C ¹	1-1/4x1-1/4x3/4	7/8	1	7/8	2-1/8	2-5/32	2-1/8	4-9/32	2-1/8	2-1/8	.41	.55
801-168	801-168C	1-1/4x1-1/4x1	7/8	25/32	7/8	2-1/8	1-29/32	2-1/8	4-1/4	2-1/8	1-3/4	.36	.37
801-202	801-202C	1-1/2x1-1/4x1	7/8	1-7/32	7/8	2-1/4	2-11/32	2-1/4	4-1/2	2-7/16	1-13/16	.40	.42
801-209F	---	1-1/2x1-1/2x1/2	11/16	1-7/16	11/16	2-1/16	2-5/16	2-1/16	4-1/8	2-5/16	1-3/8	.40	---
801-210	801-210C	1-1/2x1-1/2x3/4	11/16	1-1/32	116/16	2-1/16	2-1/32	2-1/16	4-1/8	2-5/16	1-3/8	.36	.38
801-211	801-211C	1-1/2x1-1/2x1	27/32	1-3/16	27/32	2-1/4	2-5/16	2-1/4	4-1/2	2-11/32	1-23/32	.46	.49
801-212	801-212C	1-1/2x1-1/2x1-1/4	1-3/16	1-3/16	1-3/16	2-9/16	2-7/16	2-9/16	5-1/8	2-3/8	2-1/8	.54	.57
801-247	801-247C	2x2x1/2	19/32	1-7/16	19/32	2-3/32	2-5/16	2-3/32	4-3/16	2-7/8	1-5/32	.45	.48
801-248	801-248C	2x2x3/4	11/16	1-7/16	11/16	2-3/16	2-7/16	2-3/16	4-3/8	2-7/8	1-3/8	.52	.52
801-249	801-249C	2x2x1	7/8	1-7/16	7/8	2-3/8	2-15/16	2-3/8	4-3/4	2-7/8	1-3/4	.58	.61
801-251	801-251C	2x2x1-1/2	1-3/16	1-7/16	1-3/16	2-11/32	2-13/16	2-11/16	5-3/8	2-7/8	2-3/8	.80	.84
801-287	801-287C	2-1/2x2-1/2x1/2	19/32	1-23/32	29/32	2-11/32	2-13/32	2-11/32	4-11/16	3-7/16	1-1/8	.75	.78
801-288	801-288C	2-1/2x2-1/2x3/4	7/8	1-3/4	7/8	2-7/16	2-7/8	2-7/16	4-7/8	3-1/2	1-3/8	.81	.83
801-289	801-289C	2-1/2x2-1/2x1	13/16	1-13/16	13/16	2-5/8	2-15/16	2-5/8	5-1/4	3-1/2	1-3/4	.98	1.04
801-290	801-290C	2-1/2x2-1/2x1-1/4	1-1/16	1-3/4	1-1/16	2-13/16	3	2-13/16	5-5/8	3-1/2	2-3/32	1.09	1.12
801-291	801-291C	2-1/2x2-1/2x1-1/2	1-5/32	1-3/4	1-5/32	2-15/16	3-1/8	2-15/16	5-7/8	3-1/2	2-3/8	1.18	1.24
801-292	801-292C	2-1/2x2-1/2x2	1-13/32	1-23/32	1-13/32	3-5/32	3-7/32	3-5/32	6-5/16	3-7/16	2-7/8	1.27	1.35
801-333 ¹	801-333C ¹	3x3x1/2	1-7/16	2-7/8	1-7/16	3-5/16	3-3/4	3-5/16	6-5/8	4-3/16	2-7/8	1.94	2.07
801-334 ¹	801-334C ¹	3x3x3/4	1-7/16	2-11/16	1-7/16	3-5/16	3-11/16	3-5/16	6-5/8	4-3/16	2-7/8	1.92	2.05
801-335	801-335C	3x3x1	7/8	1-31/32	7/8	2-3/4	3-3/32	2-3/4	5-1/2	4-3/16	1-23/32	1.20	1.27
801-336 ¹	801-336C ¹	3x3x1-1/4	1-5/8	1-15/16	1-5/8	3-5/16	3-5/8	3-5/16	6-5/8	4-3/16	2-7/8	1.89	1.97
801-337	801-337C	3x3x1-1/2	1-3/16	2-1/16	1-3/16	3-1/16	3-15/32	3-1/16	6-3/32	4-5/32	2-3/8	1.37	1.45
801-338	801-338C	3x3x2	1-1/2	1-27/32	1-1/2	3-13/32	3-3/8	3-13/32	6-3/4	4-3/16	2-31/32	1.78	1.69
801-339	801-339C	3x3x2-1/2	1-23/32	2-1/16	1-23/32	3-19/32	3-13/16	3-19/32	7-3/16	4-1/8	3-15/32	1.96	2.13
---	801-415C	4x4x1/2	1-7/16	3-1/2	1-7/16	3-11/16	4-3/8	3-11/16	7-3/8	5-1/4	2-7/8		2.88
801-417 ¹	801-417C ¹	4x4x1	1-15/32	3-9/32	1-15/32	3-11/16	4-3/8	3-11/16	7-3/8	5-7/32	2-7/8	2.55	2.87
801-419 ¹	801-419C ¹	4x4x1-1/2	1-7/16	3-1/4	1-7/16	3-11/16	4-13/32	3-21/32	7-11/32	5-7/32	2-7/8	2.46	2.80
801-420	801-420C	4x4x2	1-7/16	2-15/32	1-7/16	3-11/16	3-31/32	3-11/16	7-3/8	5-1/4	2-7/8	2.39	2.60
801-421 ¹	801-421C ¹	4x4x2-1/2	2-1/16	2-11/16	2-1/16	4-5/16	4-3/4	4-5/16	8-5/8	5-1/4	4-1/8	3.48	3.68
801-422	801-422C	4x4x3	2-1/16	2-21/32	2-3/32	4-11/32	4-15/32	4-11/32	8-11/16	5-7/32	4-3/16	3.09	3.22
801-482F	N/A	5x5x1-1/4	2-5/8	3-3/16	2-5/8	5-5/8	4-7/16	5-5/8	11-1/4	5-3/16	2-1/8	5.99	---
801-484F	---	5x5x1-1/2	3-3/8	4-5/8	3-3/8	6-1/8	6-1/8	6-1/8	12-1/4	6-3/8	2-3/8	9.10	---
801-486F	---	5x5x2	3-5/8	3-3/16	3-5/8	6-5/8	4-11/16	6-5/8	13-1/4	6-5/16	2-15/16	6.87	---

1: Outlet sized with bushing

PVC & CPVC SCHEDULE 80 FITTINGS, UNIONS, TANK ADAPTERS, EXPANSION JOINTS & SADDLES

REDUCING TEE (continued)

Soc x Soc x Soc

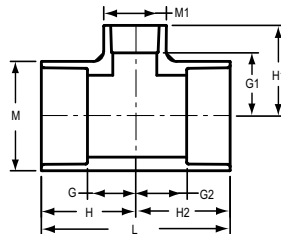

Part Number		Size	G	G1	G2	H	H1	H2	L	M	M1	Approx. Wt. (Lbs.)	
PVC	CPVC											PVC	CPVC
---	801-526C	6x6x1-1/4	2-11/16	5-9/16	2-11/16	5-9/16	6-13/16	5-9/16	11-1/8	7-1/2	5-1/4	---	9.24
801-528 ¹	---	6x6x2	2-1/16	4-5/8	2-1/16	5-1/16	6-1/8	5-1/16	10-5/32	7-9/16	4-7/32	7.00	---
---	801-528C ¹	6x6x2	2-19/32	4-7/8	2-19/32	5-19/32	6-3/8	5-19/32	11-3/16	7-1/2	5-1/4	---	9.43
801-529 ¹	801-529C ¹	6x6x2-1/2	2-5/8	4-21/32	2-5/8	5-5/8	6-3/4	5-5/8	11-1/4	7-9/16	5-1/4	6.73	8.99
801-530	---	6x6x3	2-1/16	3-3/4	2-1/16	5-1/16	5-5/8	5-1/16	10-5/32	7-9/16	4-7/32	6.37	---
---	801-530C ¹	6x6x3	2-5/8	4-3/4	2-5/8	5-5/8	6-1/2	5-5/8	11-1/4	7-9/16	5-1/4	---	9.16
801-530F	801-530CF	6x6x3	4-3/4	5-5/8	4-3/4	8	7-7/8	8	16	7-1/2	4-1/8	12.33	11.74
801-532	801-532C	6x6x4	2-19/32	3-3/4	2-19/32	5-19/32	5-15/16	5-19/32	11-3/16	7-1/2	5-1/4	7.43	8.30
801-533F	---	6x6x5	5-3/4	7	5-3/4	9	10	9	18	7-1/2	6-5/16	10.35	---
801-575 ¹	801-575C ¹	8x8x1	3-25/32	7-25/32	3-25/32	7-25/32	8-13/16	7-25/32	15-9/16	9-5/8	7-1/2	17.85	18.76
801-578 ¹	801-578C ¹	8x8x2	3-13/16	6-5/8	3-13/16	7-13/16	8-1/8	7-13/16	15-5/8	9-11/16	7-9/16	17.56	18.19
801-579F	801-579CF	8x8x2-1/2	3-1/2	4-3/4	3-1/2	7-3/4	6-1/2	7-3/4	15-1/2	9-5/8	3-9/16	17.97	16.63
801-580 ¹	801-580C ¹	8x8x3	3-23/32	6-1/2	3-23/32	7-3/4	8-3/8	7-3/4	15-1/2	9-11/16	7-1/2	17.03	18.44
801-580F	801-580CF	8x8x3	3-1/2	4-7/8	3-1/2	7-3/4	6-3/4	7-3/4	15-1/2	9-5/8	4-1/4	17.42	20.04
801-582 ¹	801-582C ¹	8x8x4	4-3/4	6-9/16	4-3/4	7-13/16	8-13/16	7-13/16	15-5/8	9-11/16	7-9/16	17.42	18.60
801-585	801-585C	8x8x6	3-13/16	-3	3-13/16	7-13/16	7-27/32	7-13/16	15-5/8	9-11/16	7-17/32	14.96	15.64
801-621F	801-621CF	10x10x2	3-5/8	5-13/16	3-5/8	8-7/8	7-5/16	8-7/8	17-3/4	11-15/16	2-15/16	19.19	27.33
801-622F	801-622CF	10x10x2-1/2	3-3/4	5-3/4	3-3/4	9	7-3/4	9	18	11-15/16	3-1/2	20.44	22.50
801-623 ¹	801-623C ¹	10x10x3	3-7/8	9	3-7/8	9-3/8	9-1/2	9-3/8	18-3/4	12	7-1/2	26.41	28.69
801-623F	801-623CF	10x10x3	4-1/4	5-7/8	4-1/4	9-1/2	7-3/4	9-1/2	19	11-15/16	4-1/4	20.67	24.27
801-624	801-624C	10x10x4	3-7/8	7-3/16	3-7/8	9-3/8	9-1/2	9-3/8	18-3/4	12-1/16	7-9/16	26.36	28.54
801-626	801-626C	10x10x6	3-7/8	5-27/32	3-7/8	9-3/8	8-27/32	9-3/8	18-3/4	12-1/16	7-9/16	23.50	25.50
801-626F	801-626CF	10x10x6	7-1/4	9	7-1/4	12-1/2	12-1/4	12-1/2	25	11-15/16	7-1/2	34.74	38.15
801-628 ¹	801-628C ¹	10x10x8	5-15/16	7-3/4	5-15/16	11-7/16	11-3/4	11-7/16	22-7/8	12-1/16	12-1/16	43.06	48.52
801-661F	801-661CF	12x12x2	3-5/8	6-3/4	3-5/8	9-7/8	8-1/4	9-7/8	19-3/4	14-1/8	2-15/16	29.04	32.33
801-662F	---	12x12x2-1/2	6-1/8	8-5/8	6-1/8	12-3/8	10-5/8	12-3/8	24-3/4	14-1/8	3-1/2	37.84	---
801-663F	801-663CF	12x12x3	4-5/16	7	4-7/32	10-9/16	8-15/16	10-19/32	21-3/16	14-1/4	4-1/4	32.26	34.63
801-664	801-664C	12x12x4	4-11/32	10-1/8	4-11/32	10-15/16	12-3/8	10-15/16	21-7/8	14-1/4	9-23/32	32.86	38.17
801-664F	801-664CF	12x12x4	5-3/8	6-3/4	5-3/8	11-5/8	9	11-5/8	23-1/4	14-1/8	5-1/4	32.86	38.17
801-665F	---	12x12x5	7-1/8	10-1/4	7-1/8	13-3/8	13-1/4	13-3/8	26-3/4	14-1/4	6-3/8	51.48	---
801-666F	801-666CF	12x12x6	4-3/4	8	4-3/4	11-1/2	12	11-1/2	22-3/4	14-1/4	9-3/4	45.37	55.70
801-668	801-668C	12x12x8	4-27/32	7-1/2	4-27/32	11-13/32	11-1/8	11-13/32	22-13/16	14-1/4	9-3/4	40.00	42.00
801-668F	801-668CF	12x12x8	8-3/4	11		15	15-1/4		30	14-1/4	9-5/8	57.91	66.12
801-670F	801-670CF	14x14x2	9-5/8	10-1/2	9-5/8	15-7/8	15-3/4	15-7/8	31-3/4	14-1/8	11-15/16	67.18	70.97
801-692F	---	14x14x2-1/2	6-3/4	9-1/4	6-3/4	13-3/4	11-1/4	13-3/4	27-1/2	15-1/2	3-5/16	55.15	---

1: Outlet sized with bushing

PVC & CPVC SCHEDULE 80 FITTINGS, UNIONS, TANK ADAPTERS, EXPANSION JOINTS & SADDLES

REDUCING TEE (continued)

Soc x Soc x Soc

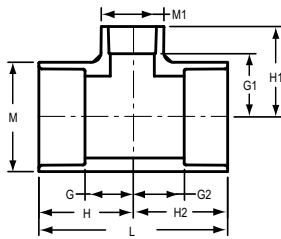

Part Number		Size	G	G1	G2	H	H1	H2	L	M	M1	Approx. Wt. (Lbs.)	
PVC	CPVC											PVC	CPVC
801-693F	801-693CF	14x14x3	4-5/8	7-1/2	4-5/8	11-5/8	9-3/8	11-5/8	23-1/4	15-1/2	4-1/4	40.35	56.80
801-694F	801-694CF	14x14x4	4-5/8	7-1/2	4-5/8	11-5/8	9-3/4	11-5/8	23-1/4	15-1/2	5-5/16	41.85	50.00
801-696F	801-696CF	14x14x6	8-1/4	10-3/8	8-1/4	15-1/4	13-5/8	15-1/4	30-1/2	15-1/2	7-1/2	63.15	63.15
801-698F	801-698CF	14x14x8	9-1/4	11-1/4	9-1/4	16-1/4	15-1/2	16-1/4	32-1/2	15-1/2	9-5/8	68.17	68.17
801-700F	801-700CF	14x14x10	10-1/8	11-1/2	10-1/8	17-1/8	16-3/4	17-1/8	34-1/4	15-1/2	11-15/16	79.05	89.80
801-702F	801-702CF	14x14x12	11	11-1/4	11	18	17-1/2	18	36	15-1/2	14-1/8	93.81	93.81
801-751F	801-751CF	16x16x2	6-5/8	10-1/8	6-5/8	14-5/8	11-7/8	14-5/8	29-1/4	17-3/4	2-7/8	55.37	71.71
801-753F	801-753CF	16x16x3	4-1/2	8-1/2	4-1/2	12-1/2	10-3/8	12-1/2	25	17-11/16	4-1/4	56.70	67.39
801-754F	801-754CF	16x16x4	5	8-1/2	5	13	10-3/4	13	26	17-3/4	5-3/16	60.66	70.21
801-756F	801-756CF	16x16x6	8-5/8	11-1/2	8-5/8	16-5/8	14-3/4	16-5/8	33-1/4	17-11/16	7-1/2	85.07	90.09
801-758F	---	16x16x8	9-5/8	12-1/4	9-5/8	17-5/8	16-1/2	17-5/8	35-1/4	17-5/8	9-5/8	94.91	---
801-760F	---	16x16x10	10-5/8	12-1/8	10-5/8	18-5/8	17-3/8	18-5/8	37-1/4	17-3/4	12	103.85	---
801-762F	801-762CF	16x16x12	11-5/8	12-1/4	11-5/8	19-5/8	18-1/2	19-5/8	39-1/4	17-5/8	14-1/8	116.70	116.70
801-764F	801-764CF	16x16x14	12-3/4	13-1/4	12-3/4	20-3/4	20-1/4	20-3/4	41-1/2	17-5/8	15-1/2	129.51	129.51
801-784F	---	18x18x4	7-1/2	12-1/4	7-1/2	16-1/2	14-1/2	16-1/2	33	19-7/8	5-1/8	91.52	---
801-786F	801-786CF	18x18x6	8-1/2	12-1/2	8-1/2	17-1/2	15-3/4	17-1/2	35	19-7/8	7-1/2	115.09	117.69
801-788F	---	18x18x8	9-1/2	13-1/4	9-1/2	18-1/2	17-1/2	18-1/2	37	19-7/8	9-5/8	118.85	---
801-790F	801-790CF	18x18x10	10-1/2	13-1/4	10-1/2	19-1/2	18-1/2	19-1/2	39	19-7/8	11-15/16	128.48	138.59
801-792F	801-792CF	18x18x12	11-1/2	13	11-1/2	20-1/2	19-1/4	20-1/2	41	19-7/8	14-1/8	151.17	150.34
801-794F	---	18x18x14	11-1/2	13-7/16	11-1/2	20-1/2	20-7/16	20-1/2	41	19-7/8	15-1/2	151.23	---
801-796F	801-796CF	18x18x16	13-1/2	13-3/4	13-1/2	22-1/2	21-3/4	22-1/2	45	19-7/8	17-11/16	140.86	172.46
801-814F	---	20x20x4	7-7/8	13-3/4	7-7/8	17-7/8	16	17-7/8	35-3/4	22-1/8	5-1/4	114.37	---
801-816F	---	20x20x6	8-7/8	13-1/2	8-7/8	18-7/8	16-3/4	18-7/8	37-3/4	22-1/8	7-1/2	130.08	---
801-818F	---	20x20x8	9-7/8	14-1/4	9-7/8	19-7/8	18-1/2	19-7/8	39-3/4	22-1/8	9-5/8	137.63	---
801-820F	---	20x20x10	10-7/8	14-1/8	10-7/8	20-7/8	19-3/8	20-7/8	41-3/4	22-1/8	12	123.96	---
801-822F	---	20x20x12	11-7/8	14-3/8	11-7/8	21-7/8	20-5/8	21-7/8	43-3/4	22-1/8	14-1/4	164.33	---
801-824F	---	20x20x14	12-7/8	14-7/8	12-7/8	22-7/8	21-7/8	22-7/8	45-3/4	22-1/8	15-5/8	176.28	---
801-826F	---	20x20x16	13-7/8	15-5/8	13-7/8	23-7/8	23-5/8	23-7/8	47-3/4	22-1/8	17-3/4	191.64	---
801-828F	---	20x20x18	14-7/8	14-1/2	14-7/8	24-7/8	24-1/2	24-7/8	49-3/4	22-1/8	20	215.72	---
801-904F	---	24x24x4	8-1/4	14-3/4	8-1/4	20-1/4	17	20-1/4	40-1/2	26-1/2	5-1/4	196.14	---
801-906F	---	24x24x6	9-1/4	15-1/8	9-1/4	21-1/4	18-3/8	21-1/4	42-1/2	26-1/2	7-1/2	207.79	---
801-908F	---	24x24x8	10-1/4	16-1/8	10-1/4	22-1/4	20-3/8	22-1/4	44-1/2	26-7/16	9-5/8	215.05	---
801-910F	---	24x24x10	11-1/4	15-7/8	11-1/4	23-1/4	21-1/8	23-1/4	46-1/2	26-1/2	12	248.46	---
801-912F	---	24x24x12	12-1/4	16-3/8	12-1/4	24-1/4	22-5/8	24-1/4	48-1/2	26-1/2	14-1/8	290.75	---
801-918F	---	24x24x18	15-1/4	16-3/4	15-1/4	27-1/4	26-3/4	27-1/4	54-1/2	26-1/2	19-7/8	303.81	---
801-920F	---	24x24x20	16-1/4	18-7/8	16-1/4	28-1/4	28-7/8	28-1/4	56-1/2	26-7/16	22-1/16	341.61	---

PVC & CPVC SCHEDULE 80 FITTINGS, UNIONS, TANK ADAPTERS, EXPANSION JOINTS & SADDLES

TEE

Soc x Soc x Fipt

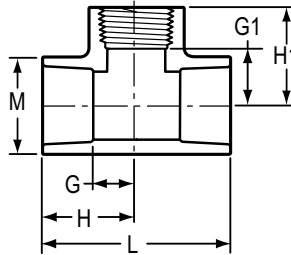

Part Number		Size	G	G1	H	H1	L	M	Approx. Wt. (Lbs.)	
PVC	CPVC								PVC	CPVC
802-002	802-002C	1/4	5/16	3/8	5/16	15/16	1-29/32	27/32	.05	.05
802-005	802-005C	1/2	19/32	21/32	1-15/32	1-11/32	2-15/16	1-3/16	.14	.15
802-007	802-007C	3/4	19/32	11/16	1-19/32	1-13/32	3-3/16	1-1/2	.14	.15
802-010	802-010C	1	23/32	1-1/16	1-27/32	2-1/16	3-11/16	1-13/32	.30	.32
802-012	802-012C	1-1/4	13/16	1-1/32	2-3/32	1-31/32	4-5/32	2-3/32	.34	.36
802-015	802-015C	1-1/2	15/16	1-7/32	2-11/32	2-5/32	4-11/16	2-11/32	.48	.51
802-020	802-020C	2	1-5/16	1-7/16	2-13/16	2-13/32	5-5/8	2-13/16	.69	.74
802-030	---	3	2-3/32	4-3/8	3-31/32	6	7-15/16	4-1/8	3.01	---

PVC & CPVC SCHEDULE 80 FITTINGS, UNIONS, TANK ADAPTERS, EXPANSION JOINTS & SADDLES

REDUCING TEE

Soc x Soc x Fipt

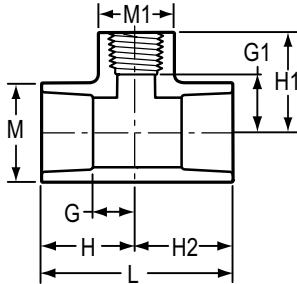

Part Number		Size	G	G1	H	H1	L	M	M1	Approx. Wt. (Lbs.)	
PVC	CPVC									PVC	CPVC
802-130 ¹	802-130C ¹	1x1x1/2	11/16	1-1/2	1-27/32	2-1/8	3-11/16	1-3/4	1-7/16	.26	.27
802-131 ¹	802-131C ¹	1x1x3/4	7/8	1-7/16	2	2-5/16	4	1-3/4	1-3/4	.31	.35
802-168 ¹	802-168C ¹	1-1/4x1-1/4x3/4	7/8	1-9/16	2-5/32	2-7/16	4-9/32	2-1/8	2-1/8	.48	.52
802-209 ¹	802-209C ¹	1-1/2x1-1/2x1/2	11/16	1-1/2	2-1/16	2-9/32	4-5/32	2-5/16	1-3/8	.39	.42
802-210 ¹	802-210C ¹	1-1/2x1-1/2x3/4	7/8	1-27/32	2-1/4	2-19/32	4-1/2	2-3/8	1-11/16	.51	.54
802-211 ¹	802-211C ¹	1-1/2x1-1/2x1	1-3/16	7/8	2-9/16	2-9/16	5-1/8	2-3/8	2-3/32	.63	.67
802-247 ¹	802-247C ¹	2x2x1/2	23/32	1-15/16	2-7/32	2-11/16	4-13/32	2-7/8	1-3/8	.52	.55
802-248 ¹	802-248C ¹	2x2x3/4	7/8	2-1/8	2-3/8	2-15/16	4-3/4	2-7/8	1-3/4	.61	.65
802-249 ¹	802-249C ¹	2x2x1	1-3/16	2-3/16	2-11/16	3-7/32	5-3/8	2-7/8	2-3/8	.94	1.28
802-251 ¹	802-251C ¹	2x2x1-1/2	1-7/16	2-5/16	2-15/16	3-11/32	5-7/8	2-7/8	2-7/8	1.20	1.21
802-289 ¹	802-289C ¹	2-1/2x2-1/2x1	1-3/32	2-11/32	2-27/32	3-1/4	5-11/16	3-1/2	2-1/8	1.19	1.21
802-290 ¹	802-290C ¹	2-1/2x2-1/2x1-1/4	1-3/16	2-15/32	2-31/32	3-15/32	5-15/16	3-1/2	2-3/8	1.30	1.34
802-291 ¹	802-291C ¹	2-1/2x2-1/2x1-1/2	1-7/16	2-1/2	3-3/16	3-1/2	6-3/8	3-1/2	2-7/8	1.51	1.55
802-292 ¹	802-292C ¹	2-1/2x2-1/2x2	1-3/4	3-15/16	3-1/2	2-7/8	7	3-15/32	3-15/32	1.86	2.15
802-333 ¹	802-333C ¹	3x3x1/2	7/8	2-11/16	2-3/4	3-7/16	5-1/2	4-1/8	1-23/32	1.27	1.30
802-334 ¹	802-334C ¹	3x3x3/4	7/8	2-19/32	2-3/4	3-11/32	5-1/2	4-3/16	1-3/4	1.26	1.33
802-335 ¹	802-335C ¹	3x3x1	1-3/16	2-31/32	3-1/16	3-7/8	6-1/8	4-1/8	2-11/32	1.53	1.61
802-337 ¹	802-337C ¹	3x3x1-1/2	1-7/16	2-23/32	3-5/16	3-23/32	6-5/8	4-1/4	2-29/32	1.84	1.98
802-338 ¹	802-338C ¹	3x3x2	2-3/32	3-11/32	3-31/32	4-3/8	7-15/16	4-5/32	4-5/32	3.03	3.51
802-339 ¹	802-339C ¹	3x3x2-1/2	2-3/32	2-3/4	3-31/32	4-5/16	7-15/16	4-1/8	4-1/8	2.90	3.34
802-416 ¹	802-416C ¹	4x4x3/4	1-15/32	3-27/32	3-23/32	4-17/32	7-7/16	5-1/4	2-7/8	2.72	2.86
802-417 ¹	802-417C ¹	4x4x1	1-7/16	3-17/32	3-23/32	4-13/32	7-13/32	5-1/4	2-7/8	2.73	2.87
802-419 ¹	802-419C ¹	4x4x1-1/2	3-11/16	3-1/2	3-11/16	3-31/32	7-3/8	5-1/4	2-7/8	2.63	2.80
802-420 ¹	802-420C ¹	4x4x2	2-1/8	3-9/16	4-11/32	4-19/32	8-23/32	5-1/4	4-3/16	3.77	4.70
802-422 ¹	802-422C ¹	4x4x3	2-5/8	3-5/8	4-7/8	5-1/4	9-3/4	5-1/4	5-1/4	5.13	5.30
802-528F	---	6x6x2	3-3/4	5-1/4	7	6-7/16	14	7-1/2	3-1/16	11.01	---
802-530 ¹	802-530C ¹	6x6x3	2-11/16	4-3/4	5-9/16	6-3/8	11-1/8	7-1/2	5-1/4	13.79	8.33
802-532F	---	6x6x4	5-1/4	5-1/8	8-1/2	6-7/8	17	7-1/2	5-1/16	13.77	---
802-578F	---	8x8x2	5-3/4	4-13/16	9	6-9/16	18	9-5/8	2-7/8	15.46	---
802-580F	---	8x8x3	5-1/4	6-1/16	9-1/2	7-11/16	19	9-5/8	4	18.24	---

¹ Outlet sized with bushing

PVC & CPVC SCHEDULE 80 FITTINGS, UNIONS, TANK ADAPTERS, EXPANSION JOINTS & SADDLES

REDUCING TEE

Soc x Soc x Fipt

(continued)

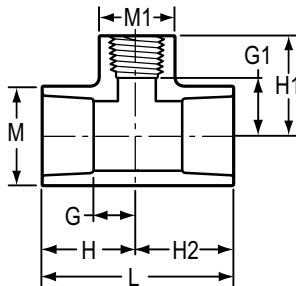

Part Number		Size	G	G1	H	H1	L	M	M1	Approx. Wt. (Lbs.)	
PVC	CPVC									PVC	CPVC
802-621F	---	10x10x2	3-7/8	8-5/16	9-3/8	9-3/8	18-3/4	12	7-1/2	26.78	---
802-623F	---	10x10x3	5-3/4	7-9/16	11	8-11/16	22	11-15/16	4	31.67	---
802-624F	---	10x10x4	6-1/4	7-1/16	11-1/2	8-13/16	23	11-15/16	5-1/16	32.18	---
802-661F	---	12x12x2	5-1/4	5-5/16	11-1/2	8-7/16	23	14-1/8	2-7/8	37.80	---
802-663F	---	12x12x3	6-1/4	7-7/8	12-1/2	9-7/16	25	14-1/8	4	36.19	---
802-664F	---	12x12x4	6-19/32	7-3/4	12-27/32	9-1/2	25-11/16	14-1/4	5-1/16	47.80	---

TEE

Soc x Soc x Metal Fipt

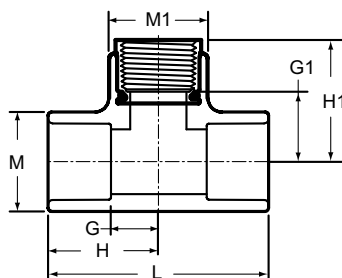

Part Number		Size	G	G1	H	H1	L	M	M1	Approx. Wt. (Lbs.)	
PVC	CPVC									PVC	CPVC
802-005BR	802-005CBR	1/2	7/8	1-5/16	1-7/16	1-7/16	2-5/8	1-5/32	1-7/32	.15	.16
802-007BR	802-007CBR	3/4	17/32	1	1-17/32	1-11/16	3-1/16	1-3/8	1-3/8	.35	.38

PVC & CPVC SCHEDULE 80 FITTINGS, UNIONS, TANK ADAPTERS, EXPANSION JOINTS & SADDLES

REDUCING TEE

Soc x Soc x Metal Fipt

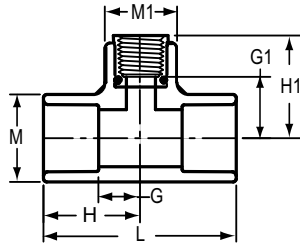

Part Number		Size	G	G1	H	H1	L	M	M1	Approx. Wt. (Lbs.)	
PVC	CPVC									PVC	CPVC
802-101BR	802-101CBR	3/4x3/4x1/2	7/16	29/32	1-7/16	1-17/32	2-7/8	1-3/8	1-3/16	.17	.26

SPECIAL REINFORCED TEE

Soc x Soc x SR Fipt

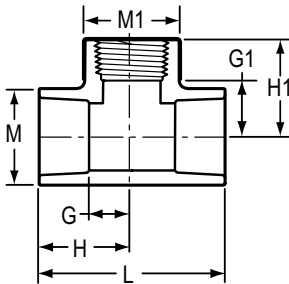

Part Number		Size	G	G1	H	H1	L	M	M1	Approx. Wt. (Lbs.)	
PVC	CPVC									PVC	CPVC
802-005SR	802-005CSR	1/2	5/8	5/8	1-15/32	1-3/8	2-15/16	1-7/32	1-7/32	.13	.13
802-007SR	805-007CSR	3/4	19/32	11/16	1-19/32	1-13/32	3-3/16	1-13/32	1-3/8	.15	.16
802-010SR	802-010CSR	1	11/16	29/32	1-13/16	1-15/16	3-5/8	1-23/32	1-23/32	.25	.28
802-012SR	802-012CSR	1-1/4	13/16	1	2-3/32	1-31/32	4-3/16	2-3/32	2-1/16	.36	.38
802-015SR	802-015CSR	1-1/2	15/16	1-7/32	2-11/32	2-5/32	4-11/16	2-11/32	2-7/16	.51	.53

PVC & CPVC SCHEDULE 80 FITTINGS, UNIONS, TANK ADAPTERS, EXPANSION JOINTS & SADDLES

SPECIAL REINFORCED REDUCING TEE

Soc x Soc x SR Fipt

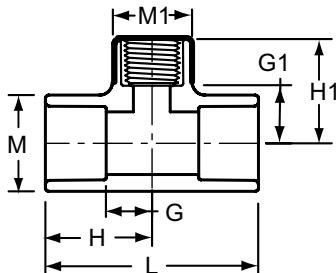

Part Number		Size	G	G1	H	H1	L	M	M1	Approx. Wt. (Lbs.)	
PVC	CPVC									PVC	CPVC
802-072SR	802-072CSR	1/2x1/2x1/4	7/16	11/16	1-5/16	1-7/32	2-5/8	1-5/32	27/32	.09	.09
802-098SR	802-098CSR	3/4x3/4x1/4	7/16	13/16	1-7/16	1-5/16	2-7/8	1-3/8	27/32	.12	.12
802-101SR	802-101CSR	3/4x3/4x1/2	5/8	25/32	1-5/8	1-15/32	3-1/4	1-3/8	1-7/32	.15	.15
802-128SR	802-128CSR	1x1x1/4	7/8	2-5/8	2	2-11/16	4	2-3/32	27/32	.43	.38
802-207SR	802-207CSR	1-1/2x1-1/2x1/4	7/8	3-1/16	2-1/4	3-9/16	2-11/32	2-11/32	27/32	.53	.57
802-211SR	802-211CSR	1-1/2x1-1/2x1	7/8	1-3/16	2-1/4	2-3/32	4-15/32	2-11/32	1-23/32	.42	.44
802-331SR	802-331CSR	3x3x1-1/4	1-13/32	4-1/2	3-5/16	5-1/32	6-9/16	4-3/16	27/32	1.90	3.62
802-413SR	802-413CSR	4x4x1-1/4	1-7/16	5-3/16	3-11/16	5-25/32	7-3/8	5-1/4	27/32	2.63	2.75

TEE

Fipt x Fipt x Fipt

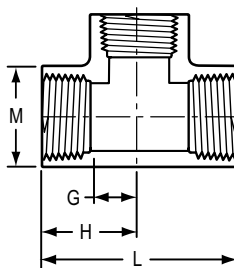

Part Number		Size	G	H	L	M	Approx. Wt. (Lbs.)	
PVC	CPVC						PVC	CPVC
805-002	805-002C	1/4	17/32	1-1/8	2-3/16	27/32	.06	.05
805-003	805-003C	3/8	9/16	1-5/32	2-5/16	15/16	.07	.07
805-005	805-005C	1/2	1/2	1-1/4	2-1/2	1-3/16	.11	.11
805-007	805-007C	3/4	5/8	1-15/32	2-15/16	1-1/2	.19	.20
805-010	805-010C	1	23/32	1-23/32	3-7/16	1-13/16	.34	.36
805-012	805-012C	1-1/4	15/16	1-15/16	3-7/8	2-1/4	.49	.52
805-015	805-015C	1-1/2	1-1/8	2-3/16	4-3/8	2-13/32	.58	.62
805-020	805-020C	2	1-5/8	2-5/8	5-1/4	3	1.08	1.15
805-025	805-025C	2-1/2	1-9/16	3-1/8	6-1/4	3-9/16	1.62	1.77
805-030	805-030C	3	1-29/32	3-17/32	7-1/16	4-5/16	2.59	3.06
805-040	805-040C	4	2-15/32	4-7/32	8-7/16	5-3/8	4.28	4.33

PVC & CPVC SCHEDULE 80 FITTINGS, UNIONS, TANK ADAPTERS, EXPANSION JOINTS & SADDLES

SPECIAL REINFORCED TEE

SR Fipt x SR Fipt x SR Fipt

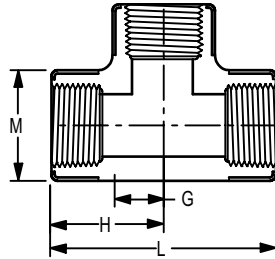

Part Number		Size	G	H	L	M	Approx. Wt. (Lbs.)	
PVC	CPVC						PVC	CPVC
805-002SR	805-002CSR	1/4	17/32	1-1/8	2-1/4	27/32	.08	.07
805-003SR	805-003CSR	3/8	9/16	1-3/16	2-11/32	31/32	.09	.09
805-005SR	805-005CSR	1/2	1/2	1-1/4	2-1/2	1-3/16	.14	.14
805-007SR	805-007CSR	3/4	1/2	1-11/32	2-11/16	1-3/8	.16	.17
805-010SR	805-010CSR	1	7/8	1-25/32	3-9/16	1-11/16	.32	.33
805-015SR	805-015CSR	1-1/2	1-1/4	2-3/16	4-13/32	2-13/32	.66	.70
805-020SR	805-020CSR	2	1-5/8	2-5/8	5-1/4	3	1.17	1.27

STREET TEE

Spig x Soc x Soc

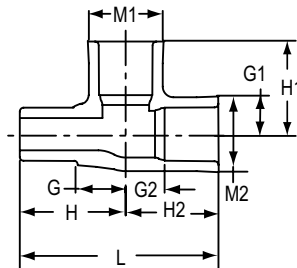

Part Number		Size	G	G1	G2	H	H1	H2	L	M1	M2	Approx. Wt. (Lbs.)	
PVC	CPVC											PVC	CPVC
844-005	844-005C	1/2	23/32	23/32	1/2	1-19/32	1-21/32	1-19/32	3-5/32	1-3/16	1-3/16	.10	.11
844-007	844-007C	3/4	13/16	27/32	7/8	1-13/16	1-7/8	1-13/16	3-5/8	1-13/32	1-13/32	.15	.16
844-010	844-010C	1	1	1-31/32	1-31/32	2-1/8	2	2-1/8	4-7/32	1-3/4	1-3/4	.26	.27
844-012	844-012C	1-1/4	1-1/4	1-5/32	1-1/8	2-7/16	2-5/16	2-7/16	4-7/8	2-3/32	2-3/32	.39	.41
844-015	844-015C	1-1/2	1-13/16	1-1/8	1-1/8	2-7/8	2-9/16	2-9/16	5-11/32	2-11/32	2-11/32	.51	.54
844-020	844-020C	2	1-19/32	1-11/16	1-19/32	3-3/32	3-3/16	3-3/32	6-1/8	2-7/8	2-7/8	.78	.83

PVC & CPVC SCHEDULE 80 FITTINGS, UNIONS, TANK ADAPTERS, EXPANSION JOINTS & SADDLES

90° ELL

Soc x Soc

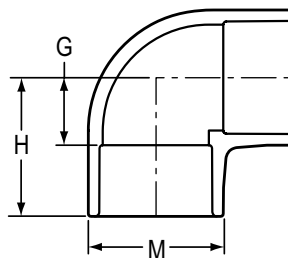

Part Number		Size	G	H	M	Approx. Wt. (Lbs.)	
PVC	CPVC					PVC	CPVC
806-002	806-002C	1/4	11/32	1	13/16	.03	.03
806-003	806-003C	3/8	15/32	1-1/4	31/32	.05	.05
806-005	806-005C	1/2	9/16	1-1/2	1-3/16	.07	.08
806-007	806-007C	3/4	11/16	1-11/16	1-13/32	.11	.12
806-010	806-010C	1	7/8	1-31/32	1-23/32	.19	.20
806-012	806-012C	1-1/4	1-1/32	2-5/16	1-31/32	.33	.35
806-015	806-015C	1-1/2	1-3/32	2-15/32	2-11/32	.39	.40
806-020	806-020C	2	1-7/16	2-15/16	2-7/8	.59	.66
806-025	806-025C	2-1/2	1-7/16	3-11/32	3-7/16	1.07	1.17
806-030	806-030C	3	2-5/32	4-1/32	4-1/8	1.54	1.81
806-040	806-040C	4	2-5/8	4-7/8	5-1/4	2.87	3.49
806-045F	---	4-1/2	7-1/8	9-11/16	5-3/8	4.58	---
806-050	806-050C	5	3	5	6-3/8	4.30	---
806-050F	---	5	5-15/16	8-15/16	6-5/16	6.23	---
806-060	---	6	3-3/4	6-3/4	7-9/16	8.53	---
---	806-060C	6	3-15/32	6-15/32	7-9/16	---	8.38
806-080	806-080C	8	4-13/16	8-27/32	9-23/32	15.80	15.96
806-080F	806-080CF	8	8-1/2	12-3/4	9-5/8	17.47	22.53
806-100	806-100C	10	5-25/32	11-11/32	12-1/16	26.67	28.74
806-100F	806-100CF	10	10	15-1/4	11-15/16	31.86	40.28
806-120	806-120C	12	6-7/8	13-7/16	14-5/16	43.94	47.93
806-120F	806-120CF	12	11-1/4	17-1/2	14-1/8	60.28	65.42
806-140F	806-140CF	14	13-1/4	20-1/4	15-1/2	82.49	84.15
806-160F	---	16	14-3/4	22-3/4	17-3/4	101.71	---
806-180F	---	18	20-1/2	29-1/2	20	167.49	---
806-200F	---	20	22-1/4	32-1/4	22-1/16	256.44	---
806-240F	---	24	27-1/4	39-1/4	26-7/16	403.66	---

PVC & CPVC SCHEDULE 80 FITTINGS, UNIONS, TANK ADAPTERS, EXPANSION JOINTS & SADDLES

90° LONG SWEEP ELL

Soc x Soc

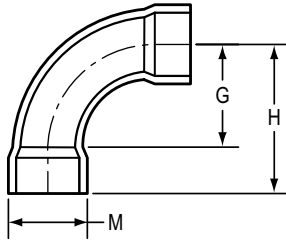

Part Number		Size	G	H	M	Approx. Wt. (Lbs.)	
PVC	CPVC					PVC	CPVC
806-005LSF	806-005LSCF	1/2	2	2-7/8	1-1/8	.13	.13
806-007LSF	806-007LSCF	3/4	2-7/16	3-7/16	1-7/16	.22	.24
806-010LSF	806-010LSCF	1	2-3/4	4	1-3/4	.33	.37
806-012LSF	806-012LSCF	1-1/4	3-5/8	4-7/8	2-1/16	.50	.56
806-015LSF	806-015LSCF	1-1/2	4-1/4	5-1/2	2-5/16	.60	.68
806-020LSF	806-020LSCF	2	4-3/4	6-5/16	2-13/16	.90	1.07
806-025LSF	806-025LSCF	2-1/2	5-3/4	7-3/4	3-7/16	1.65	1.70
806-030LSF	806-030LSCF	3	4-1/8	9	7	2.36	2.69
806-040LSF	806-040LSCF	4	9	11-1/4	5-1/8	4.76	4.85
806-060LSF	---	6	13-9/16	16-13/16	7-1/2	12.84	---
---	806-060LSCF	6	13	16-1/4	7-1/2	---	12.84
806-080LSF	806-080LSCF	8	23-1/2	27-3/4	9-5/8	31.58	33.18

90° SWEEP ELL

Soc x Soc

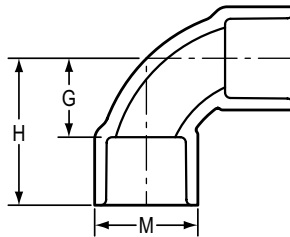

Part Number		Size	G	H	M	Approx. Wt. (Lbs.)	
PVC	CPVC					PVC	CPVC
806-005S	806-005SC	1/2	27/32	1-23/32	1-3/16	.07	.08
806-007S	806-007SC	3/4	1-1/32	2-1/32	1-13/32	.12	.12
806-010S	806-010SC	1	1-5/16	2-7/16	1-23/32	.20	.20
806-012S	806-012SC	1-1/4	1-9/16	2-13/16	2-3/32	.29	.31
806-015S	806-015SC	1-1/2	1-3/4	3-1/8	2-11/32	.38	.40
806-020S	806-020SC	2	2-5/16	3-13/16	2-7/8	.64	.68

PVC & CPVC SCHEDULE 80 FITTINGS, UNIONS, TANK ADAPTERS, EXPANSION JOINTS & SADDLES

90° ELL

Soc x Fipt

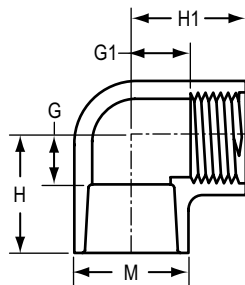

Part Number		Size	G	G1	H	H1	M	Approx. Wt. (Lbs.)	
PVC	CPVC							PVC	CPVC
807-002	807-002C	1/4	11/32	11/32	31/32	31/32	27/32	.03	.03
807-003	807-003C	3/8	1/4	3/8	1-1/32	1-1/32	1-1/32	.05	.05
807-005	807-005C	1/2	15/32	9/16	1-11/32	1-9/32	1-3/16	.08	.11
807-007	807-007C	3/4	21/32	27/32	1-21/32	1-21/32	1-1/2	.15	.15
807-010	807-010C	1	23/32	7/8	1-29/32	1-27/32	1-13/16	.22	.24
807-012	807-012C	1-1/4	31/32	1	2-7/32	1-15/16	2-1/4	.36	.37
807-015	807-015C	1-1/2	31/32	1-5/32	2-3/8	2-1/8	2-11/32	.38	.46
807-020	807-020C	2	1-3/8	1-1/2	2-29/32	2-5/8	3	.80	.84
807-030 ¹	---	3	2-3/16	4-5/16	4-1/16	5-11/16	4-1/8	2.46	---
807-040 ¹	---	4	2-5/8	5-1/4	4-7/8	6-15/16	5-1/4	4.21	---
807-060 ¹	---	6	3-3/4	7-1/8	6-3/4	8-7/8	7-9/16	11.48	---

¹ Outlet sized with Female Adapter

SPECIAL REINFORCED 90° ELL

Soc x SR Fipt

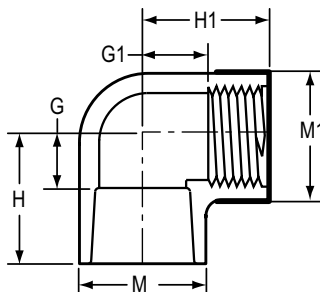

Part Number		Size	G	G1	H	H1	M	M1	Approx. Wt. (Lbs.)	
PVC	CPVC								PVC	CPVC
807-005SR	807-005CSR	1/2	15/32	23/32	1-11/32	1-9/32	1-3/16	1-7/32	.08	.09
807-010SR	807-010CSR	1	5/8	27/32	1-3/4	1-3/4	1-23/32	1-23/32	.21	.21
807-015SR	807-015CSR	1-1/2	31/32	1-5/32	2-3/8	2-1/8	2-11/32	2-7/16	.41	.44
807-020SR	807-020CSR	2	1-7/32	1-1/2	2-15/32	2-7/16	2-31/32	2-31/32	.98	.91
807-040SR	---	4	2-3/8	5-5/16	4-5/8	6-13/16	5-1/4	5-1/4	3.70	---

PVC & CPVC SCHEDULE 80 FITTINGS, UNIONS, TANK ADAPTERS, EXPANSION JOINTS & SADDLES

SPECIAL REINFORCED REDUCING 90° ELL

Soc x SR Fipt

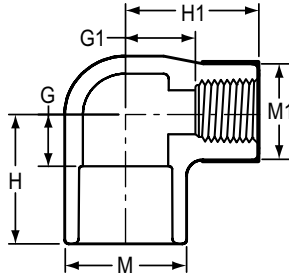

Part Number		Size	G	G1	H	H1	M	M1	Approx. Wt. (Lbs.)	
PVC	CPVC								PVC	CPVC
807-101SR	807-101CSR	3/4x1/2	17/32	7/8	1-17/32	1-17/32	1-13/32	1-3/16	.11	.11
807-130SR	807-130CSR	1x1/2	9/16	1	1-23/32	1-5/8	1-23/32	1-3/16	.13	.14

TRANSITION 90° ELL

Soc x Metal Fipt

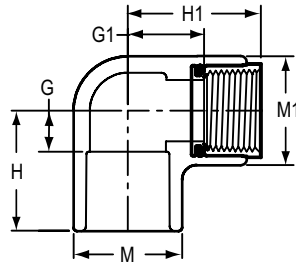

Part Number		Size	G	G1	H	H1	M	M1	Approx. Wt. (Lbs.)	
PVC	CPVC								PVC	CPVC
807-005BR	807-005CBR	1/2	7/16	25/32	1-5/16	1-7/16	1-7/32	1-7/32	.18	.19
807-007BR	807-007CBR	3/4	1/2	1-1/32	1-1/2	1-21/32	1-3/8	1-3/8	.17	.19

TRANSITION REDUCING 90° ELL

Soc x Metal Fipt

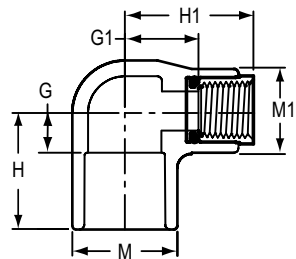

Part Number		Size	G	G1	H	H1	M	M1	Approx. Wt. (Lbs.)	
PVC	CPVC								PVC	CPVC
807-101BR	807-101CBR	3/4x1/2	1/2	7/8	1-1/2	1-17/32	1-3/8	1-7/32	.28	.21

PVC & CPVC SCHEDULE 80 FITTINGS, UNIONS, TANK ADAPTERS, EXPANSION JOINTS & SADDLES

90° ELL

Fipt x Fipt

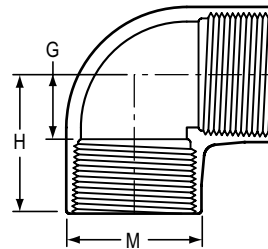

Part Number		Size	G	H	M	Approx. Wt. (Lbs.)	
PVC	CPVC					PVC	CPVC
808-002	808-002C	1/4	11/32	15/16	27/32	.03	.04
808-003	808-003C	3/8	17/32	1-5/32	15/16	.06	.07
808-005	808-005C	1/2	1/2	1-7/32	1-9/32	.09	.08
808-007	808-007C	3/4	5/8	1-3/8	1-3/8	.11	.13
808-010	808-010C	1	11/16	1-11/16	1-27/32	.22	.24
808-012	808-012C	1-1/4	15/16	1-15/16	2-1/4	.41	.38
808-015	808-015C	1-1/2	1-5/32	2-3/16	2-1/2	.57	.48
808-020	808-020C	2	1-13/32	2-1/2	3	.82	.89
808-025	808-025C	2-1/2	1-5/8	3-3/16	3-9/16	1.20	1.26
808-030	808-030C	3	2	3-9/16	4-5/16	1.85	1.96
808-040	808-040C	4	2-13/32	4-5/32	5-7/16	3.22	3.44

SPECIAL REINFORCED 90° ELL

SR Fipt x SR Fipt

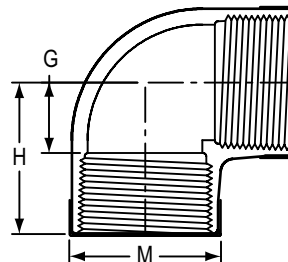

Part Number		Size	G	H	M	Approx. Wt. (Lbs.)	
PVC	CPVC					PVC	CPVC
808-003SR	808-003CSR	3/8	17/32	1-5/32	15/16	.07	.07
808-005SR	808-005CSR	1/2	1/2	1-7/32	1-3/16	.10	.11
808-007SR	808-007CSR	3/4	5/8	1-3/8	1-3/8	.13	.14
808-010SR	808-010CSR	1	25/32	1-11/16	1-23/32	.23	.24
808-012SR	808-012CSR	1-1/4	1	1-31/32	2-1/16	.34	.45
808-015SR	808-015CSR	1-1/2	1-1/32	2-1/8	2-7/16	.50	.52
808-020SR	808-020CSR	2	1-1/2	2-1/2	3	1.00	1.04

PVC & CPVC SCHEDULE 80 FITTINGS, UNIONS, TANK ADAPTERS, EXPANSION JOINTS & SADDLES

90° STREET ELL

Spig x Soc

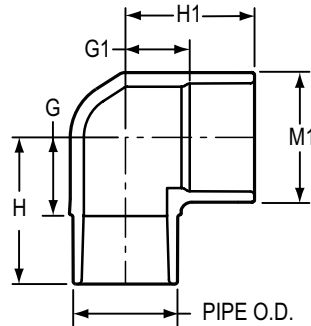

Part Number		Size	G	G1	H	H1	M1	Approx. Wt. (Lbs.)	
PVC	CPVC							PVC	CPVC
809-005	809-005C	1/2	13/16	7/16	1-21/32	1-7/16	1-5/32	.07	.08
809-007	809-007C	3/4	29/32	11/16	1-27/32	1-11/16	1-3/8	.11	.12
809-010	809-010C	1	7/8	1-11/32	2-1/16	2-1/4	1-23/32	.19	.20
809-012	809-012C	1-1/4	1-9/32	13/16	2-19/32	2-1/4	2-3/32	.29	.31
809-015	809-015C	1-1/2	1-7/16	1-3/16	2-13/16	2-9/16	2-3/8	.40	.43
809-020	809-020C	2	1-3/4	1-7/16	3-1/4	2-31/32	2-7/8	.60	.64
809-030	809-030C	3	2-7/8	1-7/8	5	3-3/4	4-3/16	1.87	2.35
809-040	809-040C	4	3-9/16	2-7/16	6-1/16	4-11/16	5-1/4	3.41	5.04
809-060	---	6	5-1/4	3-7/8	8-1/2	6-7/8	7-9/16	12.00	---
---	809-060C	6	4-7/8	3-3/8	8-1/8	6-3/8	7-5/8	---	10.01
809-080	809-080C	8	6-7/8	5	11-1/8	8-7/8	9-11/16	13.74	23.19
809-100	809-100C	10	8-5/8	5-13/16	14-5/16	11-3/8	12-1/16	37.73	41.05
809-120	809-120C	12	10-1/8	6-7/8	16-7/8	13-3/8	14-1/8	61.75	67.93

90° STREET ELL

Mipt x Fipt

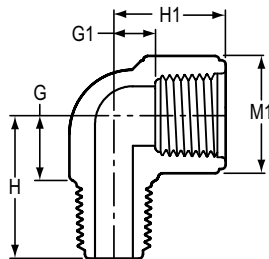

Part Number		Size	G	G1	H	H1	M1	Approx. Wt. (Lbs.)	
PVC	CPVC							PVC	CPVC
812-002	812-002C	1/4	17/32	5/16	1-1/32	29/32	13/16	.02	.02

PVC & CPVC SCHEDULE 80 FITTINGS, UNIONS, TANK ADAPTERS, EXPANSION JOINTS & SADDLES

11-1/4° ELL

Soc x Soc

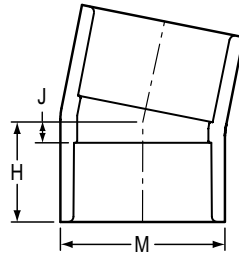

Part Number		Size	H	J	M	Approx. Wt. (Lbs.)	
PVC	CPVC					PVC	CPVC
811-020	811-020C	2	1-23/32	7/32	2-27/32	.33	.35
811-025F	---	2-1/2	2-3/4	3/4	3-3/8	.81	---
811-030	811-030C	3	1-7/8	5/16	4-1/8	.88	.92
811-040	811-040C	4	2-21/32	13/32	5-1/4	1.53	1.58
811-045F	---	4-1/2	3-7/8	1-3/8	5-5/8	1.94	---
811-050F	---	5	4	1-1/4	6-5/16	2.88	---
811-060F	811-060CF	6	4-1/2	1-1/4	7-1/2	4.43	5.38
811-080F	811-080CF	8	5-27/32	1-23/32	9-5/8	8.73	10.52
811-100F	811-100CF	10	7-3/8	2-1/8	12	15.93	19.02
811-120F	811-120CF	12	7-1/2	1-1/4	14-1/8	24.66	29.25
811-140F	811-140CF	14	9	2	15-1/2	33.00	41.37
811-160F	---	16	10-3/8	2-3/8	17-3/4	48.74	---
811-180F	---	18	12	3	19-7/8	69.12	---
811-200F	---	20	13-5/16	3-5/16	22-1/16	119.89	---
811-240F	---	24	15	4	26-1/2	152.00	---

30° ELL

Soc x Soc

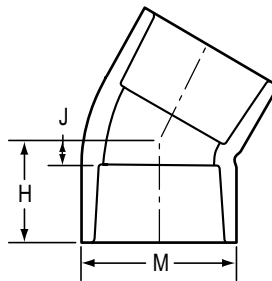

Part Number		Size	H	J	M	Approx. Wt. (Lbs.)	
PVC	CPVC					PVC	CPVC
815-020F	815-020CF	2	2-1/2	29/32	2-27/32	.46	.54
815-025F	---	2-1/2	3-3/8	1-3/8	3-1/2	.81	---
815-030F	815-030CF	3	3-1/8	7/8	4-1/8	1.21	1.44
815-040F	815-040CF	4	3-1/2	1-1/4	5-3/16	2.14	2.27
815-045F	---	4-1/2	4-3/8	1-7/8	5-3/8	2.18	---
815-050F	---	5	4-1/2	1-3/4	6-5/16	3.10	---
815-060	815-060C	6	4-13/16	1-7/8	7-9/16	5.59	6.10
815-080F	815-080CF	8	6	1-3/4	9-5/8	10.08	11.08

PVC & CPVC SCHEDULE 80 FITTINGS, UNIONS, TANK ADAPTERS, EXPANSION JOINTS & SADDLES

30° ELL (continued)

Soc x Soc

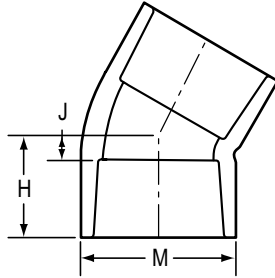

Part Number		Size	H	J	M	Approx. Wt. (Lbs.)	
PVC	CPVC					PVC	CPVC
815-100F	815-100CF	10	7-7/8	2-5/8	12	17.92	21.26
815-120F	815-120CF	12	8-15/16	2-11/16	14-1/4	27.40	32.33
815-140F	815-140CF	14	10-3/8	3-3/8	15-1/2	37.94	37.18
815-160F	---	16	11-3/4	3-3/4	17-11/16	55.09	---
815-180F	---	18	14	5-7/16	20	69.00	---
815-200F	---	20	15-1/4	5-1/4	22-1/8	119.89	---
815-240F	---	24	17-3/8	5-3/8	26-7/16	194.75	---

22-1/2° ELL

Soc x Soc

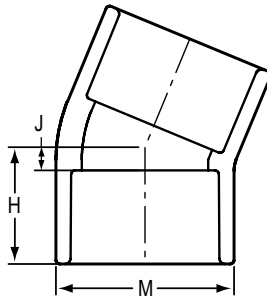

Part Number		Size	H	J	M	Approx. Wt. (Lbs.)	
PVC	CPVC					PVC	CPVC
816-005	816-005C	1/2	1-1/16	3/16	1-5/32	.06	.06
816-007	816-007C	3/4	1-3/16	7/32	1-13/32	.08	.09
816-010	816-010C	1	1-3/8	9/32	1-23/32	.13	.14
816-012	816-012C	1-1/4	1-1/2	5/16	2-3/32	.19	.20
816-015	816-015C	1-1/2	1-7/8	1-1/2	2-11/16	.25	.26
816-015F	816-015CF	1-1/2	2-3/16	11/16	2-3/8	.26	.28
816-020	816-020C	2	1-7/8	7/16	2-7/8	.41	.44
816-025 ¹	---	2-1/2	2-31/32	29/32	4-5/32	1.75	---
816-025F	816-025CF	2-1/2	3-1/4	1-1/4	3-1/2	.84	.95
816-030	816-030C	3	2-13/32	9/16	4-5/32	.97	1.01
816-040	816-040C	4	2-7/8	5/8	5-1/4	1.64	1.71
816-045F	---	4-1/2	4-1/8	1-5/8	5-5/8	2.09	---
816-050F	---	5	4-1/2	1-1/2	6-5/16	3.15	---

1: Outlet sized with bushing

PVC & CPVC SCHEDULE 80 FITTINGS, UNIONS, TANK ADAPTERS, EXPANSION JOINTS & SADDLES

22-1/2° ELL

Soc x Soc

(continued)

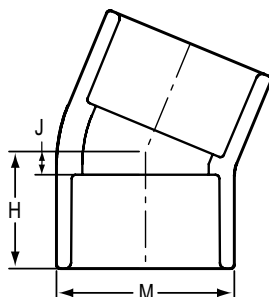

Part Number		Size	H	J	M	Approx. Wt. (Lbs.)	
PVC	CPVC					PVC	CPVC
816-060	816-060C	6	4-9/16	1-9/32	7-7/16	4.33	4.52
816-060F	816-060CF	6	4-29/32	1-9/32	7-7/16	5.02	5.29
816-080	816-080C	8	5-1/16	1-1/32	9-3/4	8.19	8.95
816-080F	816-080CF	8	6	1-3/4	9-5/8	9.41	9.60
816-100F	816-100CF	10	7-1/8	1-7/8	12	17.25	18.77
816-120F	816-120CF	12	8-1/2	2-1/4	14-1/8	26.03	30.79
816-140F	816-140CF	14	9-7/8	2-7/8	15-1/2	34.65	40.74
816-160F	---	16	11-3/8	3-3/8	17-11/16	52.97	---
816-180F	---	18	12-1/4	3-1/4	19-7/8	74.44	---
816-200F	---	20	14-5/8	4-5/8	22-1/8	119.89	---
816-240F	---	24	17-1/2	5-1/2	26-7/16	189.96	---

22-1/2° STREET ELL

Spig x Soc

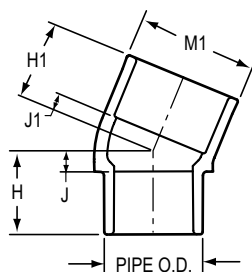

Part Number		Size	H	H1	J	J1	M1	Approx. Wt. (Lbs.)	
PVC	CPVC							PVC	CPVC
842-005	842-005C	1/2	1-1/16	1	1/4	1/4	1-5/32	.05	.05
842-007	842-007C	3/4	1-1/4	1-5/32	3/16	3/16	1-3/8	.08	.09
842-010	882-010C	1	1-15/32	1-3/8	9/32	9/32	1-23/32	.13	.14
842-012	882-012C	1-1/4	1-9/16	1-1/2	9/16	5/8	2-1/16	.20	.22
842-015	842-015C	1-1/2	1-13/16	1-3/4	1/4	11/32	2-11/32	.27	.29
842-020	842-020C	2	1-15/16	1-19/32	9/16	1/4	2-7/8	.43	.43
842-025F	842-025CF	2-1/2	4	3-1/8	2-1/8	1-1/8	3-7/16	1.28	1.58
842-030	842-030C	3	3-5/8	2-3/8	1-1/2	9/16	4-1/8	1.44	1.47
842-040	842-040C	4	4-3/8	2-7/8	1-7/8	5/8	5-1/4	2.57	2.59
842-060	842-060C	6	5-11/16	3-15/16	2-3/8	7/8	7-5/8	9.46	6.87
842-080	842-080C	8	7-3/8	5-1/8	3-1/8	1-1/8	9-3/4	5.61	12.71

PVC & CPVC SCHEDULE 80 FITTINGS, UNIONS, TANK ADAPTERS, EXPANSION JOINTS & SADDLES

45° ELL

Soc x Soc

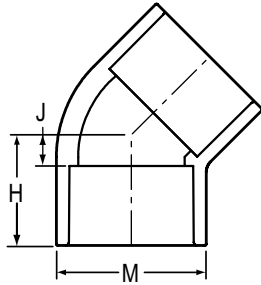

Part Number		Size	H	J	M	Approx. Wt. (Lbs.)	
PVC	CPVC					PVC	CPVC
817-002	817-002C	1/4	13/16	5/32	27/32	.03	.03
817-003	817-003C	3/8	31/32	7/32	1	.04	.04
817-005	817-005C	1/2	1-3/16	5/16	1-3/16	.06	.07
817-007	817-007C	3/4	1-11/32	11/32	1-13/32	.09	.10
817-010	817-010C	1	1-7/16	11/32	1-23/32	.15	.16
817-012	817-012C	1-1/4	1-11/16	13/32	2-3/32	.21	.22
817-015	817-015C	1-1/2	1-27/32	7/16	2-3/8	.30	.32
817-020	817-020C	2	2-5/32	21/32	2-7/8	.48	.47
817-025	817-025C	2-1/2	2-17/32	25/32	3-1/2	.84	.89
817-030	817-030C	3	2-27/32	31/32	4-1/8	1.13	1.22
817-040	817-040C	4	3-3/8	1-3/32	5-1/4	2.24	2.31
817-045F	---	4-1/2	4-1/2	2	5-5/8	2.32	---
817-050	817-050C	5	4-15/16	2-5/16	6-3/8	3.19	---
817-050F	---	5	4-1/2	1-1/2	6-5/16	3.86	---
817-060	817-060C	6	4-7/8	1-7/8	7-9/16	5.37	5.62
817-080	817-080C	8	6	2	9-5/8	9.98	10.70
817-100	817-100C	10	8-3/16	2-11/16	12	19.68	21.29
817-100F	817-100CF	10	8-1/2	3-1/4	11-15/16	19.91	23.50
817-120	817-120C	12	10-3/8	4-1/8	14-1/8	32.29	35.49
817-140F	817-140CF	14	11-1/8	4-1/8	15-1/2	42.89	41.37
817-160F	817-160CF	16	13-1/2	5-1/2	17-3/4	61.45	57.91
817-180F	---	18	15	6	20	87.73	---
817-200F	---	20	16	6	22-1/16	115.07	---
817-240F	---	24	19-7/16	7-7/16	26-7/16	204.20	---

PVC & CPVC SCHEDULE 80 FITTINGS, UNIONS, TANK ADAPTERS, EXPANSION JOINTS & SADDLES

15° ELL

Soc x Soc

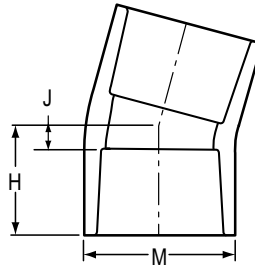

Part Number		Size	H	J	M	Approx. Wt. (Lbs.)	
PVC	CPVC					PVC	CPVC
818-020F	818-020CF	2	2-1/2	3/4	2-3/4	.42	.54
818-025F	818-025CF	2-1/2	3	1	3-3/8	.79	.69
818-030F	818-030CF	3	3	3/4	4-1/8	1.10	1.44
818-040F	818-040CF	4	3-17/32	1-7/32	5-5/32	1.90	1.96
818-045F	---	4-1/2	4	1-1/2	5-5/8	2.00	---
818-050F	---	5	4-1/4	1-1/2	6-5/16	2.98	---
818-060F	818-060CF	6	4-1/2	1-1/4	7-1/2	4.43	5.38
818-080F	818-080CF	8	5-5/8	1-3/8	9-5/8	8.73	10.52
818-100F	818-100CF	10	7-5/8	2-3/8	12	15.93	19.02
818-120F	818-120CF	12	8-1/16	1-13/16	14-1/8	24.66	29.25
818-140F	---	14	9-3/8	2-3/8	15-1/2	34.65	---
818-160F	---	16	10-7/8	2-7/8	17-3/4	50.85	---
818-180F	---	18	12-1/4	3-1/4	19-7/8	71.78	---
818-200F	---	20	14	4	22-1/8	119.89	---
818-240F	---	24	18-7/16	7-7/16	26-7/16	170.96	---

PVC & CPVC SCHEDULE 80 FITTINGS, UNIONS, TANK ADAPTERS, EXPANSION JOINTS & SADDLES

45° ELL

Fipt x Fipt

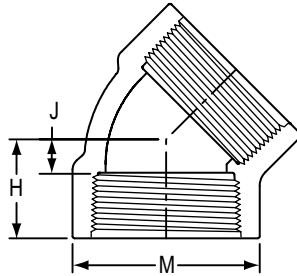

Part Number		Size	H	J	M	Approx. Wt. (Lbs.)	
PVC	CPVC					PVC	CPVC
819-002	819-002C	1/4	25/32	3/16	27/32	.03	.03
819-003	819-003C	3/8	13/16	3/16	1	.04	.04
819-005	819-005C	1/2	1-1/32	9/32	1-9/32	.07	.08
819-007	819-007C	3/4	1-3/32	13/32	1-3/8	.11	.07
819-010	819-010C	1	1-13/32	13/32	1-13/16	.16	.17
819-012	819-012C	1-1/4	1-7/16	7/16	2-3/16	.24	.25
819-015	819-015C	1-1/2	1-1/2	15/32	2-1/2	.31	.33
819-020	819-020C	2	1-23/32	21/32	3	.46	.48
819-025	819-025C	2-1/2	2-17/32	31/32	3-1/2	1.14	1.24
819-030	819-030C	3	2-23/32	1	4-9/32	1.78	1.92
819-040	819-040C	4	3-1/4	1-7/32	5-1/4	2.71	2.79

SPECIAL REINFORCED 45° ELL

SR Fipt x SR Fipt

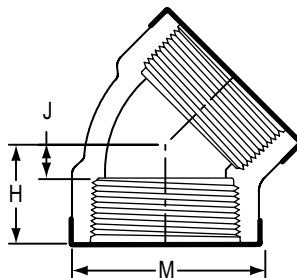

Part Number		Size	H	J	M	Approx. Wt. (Lbs.)	
PVC	CPVC					PVC	CPVC
819-007SR	819-007CSR	3/4	1-1/8	13/32	1-3/8	.10	.11

PVC & CPVC SCHEDULE 80 FITTINGS, UNIONS, TANK ADAPTERS, EXPANSION JOINTS & SADDLES

60° ELL

Soc x Soc

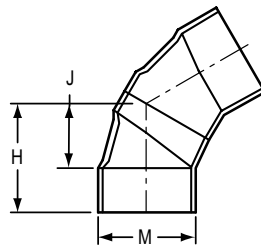

Part Number		Size	H	J	M	Approx. Wt. (Lbs.)	
PVC	CPVC					PVC	CPVC
824-020F	824-020CF	2	2-7/8	1-1/8	2-13/16	.93	1.10
824-040F	824-040CF	4	7	4-3/4	5-3/16	4.05	5.10
824-060F	824-060CF	6	8-1/4	5	7-1/2	9.30	10.87
824-080F	824-080CF	8	11-1/16	6-13/16	9-5/8	18.81	19.49
824-100F	---	10	12-3/4	7-1/2	11-15/16	33.04	---
824-200F	---	20	25-3/8	15-3/8	22-1/16	239.76	---

45° STREET ELL

Spig x Soc

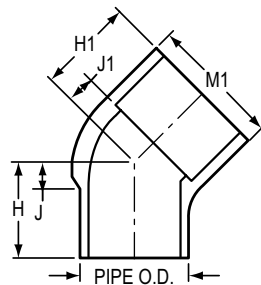

Part Number		Size	H	H1	J	J1	M1	Approx. Wt. (Lbs.)	
PVC	CPVC							PVC	CPVC
827-005	827-005C	1/2	1-9/32	1-5/16	11/32	7/16	1-3/16	.06	.06
827-007	827-007C	3/4	1-1/2	1-1/2	7/16	1/2	1-13/32	.10	.10
827-010	827-010C	1	1-19/32	1-11/16	13/32	19/32	1	.15	.16
827-012	827-012C	1-1/4	1-25/32	1-29/32	1/2	21/32	1-21/32	.22	.24
827-015	827-015C	1-1/2	2-1/32	2-1/8	19/32	25/32	2-11/32	.30	.32
827-020	827-020C	2	2-5/16	2-11/32	11/16	3/8	2-27/32	.44	.47
827-030	827-030C	3	3-1/4	3	1-1/8	1-1/8	4-5/32	1.19	1.25
827-040	827-040C	4	3-13/16	3-13/16	1-9/32	1-9/16	5-1/4	2.07	2.20
827-060	827-060C	6	5-1/8	4-3/4	2-1/8	1-3/4	7-9/16	5.70	5.87
827-080	827-080C	8	6-5/8	6	2-5/8	2	9-3/4	10.53	11.15

PVC & CPVC SCHEDULE 80 FITTINGS, UNIONS, TANK ADAPTERS, EXPANSION JOINTS & SADDLES

CROSS

Soc x Soc x Soc x Soc

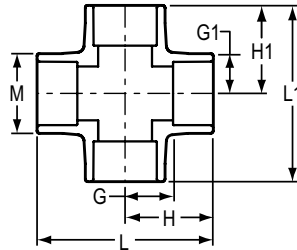

Part Number		Size	G	G1	H	H1	L	L1	M	Approx. Wt. (Lbs.)	
PVC	CPVC									PVC	CPVC
820-002	820-002C	1/4	13/32	13/32	1-1/32	1-1/32	2-1/16	2-1/16	27/32	.05	.05
820-005	820-005C	1/2	9/16	9/16	1-15/32	1-15/32	2-15/16	2-15/16	1-3/16	.19	.13
820-007	820-007C	3/4	5/8	5/8	1-5/8	1-5/8	3-9/32	3-9/32	1-13/32	.22	.21
820-010	820-010C	1	1	1	2-3/16	2-3/16	4-7/32	4-7/32	1-23/32	.43	.46
820-012	820-012C	1-1/4	1-3/32	1-3/32	2-3/8	2-3/8	4-3/4	4-3/4	2-3/32	.61	.65
820-015	820-015C	1-1/2	1-1/4	1-7/32	2-21/32	2-5/8	5-9/32	5-1/4	2-3/8	.80	.86
820-020	820-020C	2	1-17/32	1-17/32	3	3	6	6	2-31/32	1.34	1.43
820-025	820-025C	2-1/2	1-3/4	1-3/4	3-7/16	3-7/16	6-7/8	6-7/8	3-7/16	2.02	2.11
820-030	820-030C	3	2-3/32	2-3/32	3-31/32	3-31/32	7-15/16	7-15/16	4-5/32	2.97	3.10
820-040	820-040C	4	2-5/8	2-5/8	4-7/8	4-7/8	9-3/4	9-3/4	5-1/4	5.20	5.50
820-060F	820-060CF	6	6-1/4	6-1/4	9-1/2	9-1/2	19	19	7-1/2	16.19	19.09
820-080F	820-080CF	8	7-5/8	7-5/8	11-7/8	11-7/8	23-3/4	23-3/4	9-5/8	28.22	40.50
820-100F	820-100CF	10	9	9	14-1/4	14-1/4	28-1/2	28-1/2	11-15/16	49.78	67.20
820-120F	820-120CF	12	11-1/4	11-1/4	17-1/2	17-1/2	35	35	14-1/8	80.83	107.80
820-140F	820-140CF	14	11-1/4	11-1/4	18-1/4	18-1/4	36-1/2	36-1/2	15-1/2	108.89	148.16
820-160F	820-160CF	16	13	13	21	21	42	42	17-11/16	180.80	---
820-180F	---	18	13-3/4	13-3/4	22-3/4	22-3/4	45-1/2	45-1/2	19-7/8	215.35	---
820-200F	---	20	16-1/4	16-1/2	26-1/4	26-1/2	52-1/2	53	22-1/8	306.40	---
820-240F	---	24	17-3/4	17-3/4	28-3/4	28-3/4	57-1/2	57-1/2	26-1/2	527.13	---

PVC & CPVC SCHEDULE 80 FITTINGS, UNIONS, TANK ADAPTERS, EXPANSION JOINTS & SADDLES

REDUCING CROSS

Soc x Soc x Soc x Soc

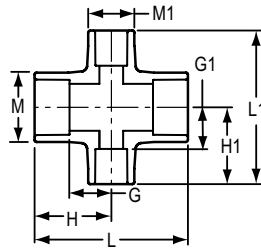

Part Number		Size	G	G1	H	H1	L	L1	M	M1	Approx. Wt. (Lbs.)	
PVC	CPVC										PVC	CPVC
820-130 ¹	820-130C ¹	1x1x1/2x1/2	1	1-7/16	2-1/8	2-3/8	4-7/32	4-3/4	1-23/32	1-23/32	.56	.59
820-166 ¹	820-166C ¹	1-1/4x1-1/4x1/2x1/2	1-3/32	1-3/32	2-3/8	2-11/16	4-3/4	5-3/16	3-3/32	3-3/32	.82	.84
820-167	820-167C	1-1/4x1-1/4x3/4x3/4	1-1/16	23/32	2-1/16	1-31/32	4-3/32	3-31/32	2-1/16	1-13/32	.33	.35
820-209 ¹	820-209C ¹	1-1/2x1-1/2x1/2x1/2	1-7/32	1-7/32	2-21/32	2-31/32	5-1/4	5-15/16	2-3/8	2-3/8	1.18	1.21
820-211 ¹	820-211C ¹	1-1/2x1-1/2x1x1	1-3/4	1-3/4	2-5/8	3	5-5/16	5-7/8	1-3/8	1-3/8	1.12	1.16
820-251	---	2x2x1-1/2x1-1/2	1-1/2	2	3	3-3/8	6	6-3/4	2-7/8	2-7/8	1.72	---
820-291 ¹	820-291C ¹	2-1/2x2-1/2x1-1/2x1-1/2	1-11/16	2-15/32	3-7/16	3-27/32	6-7/8	7-23/32	3-9/16	3-9/16	2.83	2.97
820-336 ¹	820-336C ¹	3x3x1-1/4x1-1/4	2-3/32	3-1/8	3-31/32	4-3/8	7-29/32	8-3/4	4-3/16	4-3/16	4.23	4.46
820-420F	820-420CF	4x4x2x2	3-7/8	4-5/16	6-1/8	6-1/16	12-1/4	12-1/8	5-3/16	2-11/16	5.26	5.79
820-422 ¹	820-422C ¹	4x4x3x3	2-5/8	3-7/16	4-7/8	5-5/16	9-3/4	10-5/8	5-1/4	5-1/4	6.94	7-21
820-528F	820-528CF	6x6x2x2	3-3/4	3-3/4	7	5-1/4	14	10-1/2	7-1/2	2-15/16	7.19	7.80
820-530F	820-530CF	6x6x3x3	4-3/4	5-5/8	8	7-7/8	16	15-3/4	7-1/2	4-1/8	12.60	13.30
820-532F	820-532CF	6x6x4x4	5-1/4	6-5/8	8-1/2	8-7/8	17	17-3/4	7-1/2	5-3/16	14.54	15.93
820-533F	---	6x6x5x5	5-3/4	7	9	10	18	20	7-1/2	6-5/16	---	---
820-578F	820-578CF	8x8x2x2	3-1/4	4-3/4	7-1/2	6-1/4	15	12-1/2	9-5/8	2-15/16	11.30	15.90
820-580F	820-580CF	8x8x3x3	3-1/2	4-7/8	7-3/4	6-3/4	15-1/2	13-1/2	9-5/8	4-1/4	12.93	13.77
820-582F	820-582CF	8x8x4x4	5-3/4	8	10	10-1/4	20	20-1/2	9-5/8	5-1/4	21.87	24.71
820-585F	820-585CF	8x8x6x6	6-3/4	8	11	11-1/4	22	22-1/2	9-5/8	7-1/2	28.35	30.75
820-621F	820-621CF	10x10x2x2	3-5/8	5-13/16	8-7/8	7-5/16	17-3/4	14-5/8	11-15/16	2-15/16	19.45	27.78
820-622F	---	10x10x2-1/2x2-1/2	3-3/4	5-3/4	9	7-3/4	18	15-1/2	11-15/16	3-1/2	20.00	---
820-623F	820-623CF	10x10x3x3	4-1/4	5-7/8	9-1/2	7-3/4	19	15-1/8	11-15/16	4-1/4	21.42	30.16
820-624F	820-624CF	10x10x4x4	4-3/4	5-3/4	10	8	20	16	11-15/16	5-1/4	24.17	28.17
820-626F	820-626CF	10x10x6x6	7-1/4	9	12-1/2	12-1/4	25	24-1/2	11-15/16	7-1/2	40.79	38.61
820-628F	820-628CF	10x10x8x8	8-1/4	9-3/4	13-1/2	14	27	28	12	9-5/8	65.94	59.10
820-661F	820-661CF	12x12x2x2	5-5/8	8-1/2	11-7/8	10-1/4	23-3/4	20-1/2	14-1/8	2-7/8	29.32	44.02
820-663F	820-663CF	12x12x3x3	6-1/8	8-13/16	12-3/8	11-1/16	24-3/4	22-1/8	14-1/8	4-1/8	33.02	45.28
820-664F	820-664CF	12x12x4x4	5-3/8	6-3/4	11-5/8	9	23-1/4	18	14-1/8	5-1/4	33.78	39.39
820-666F	820-666CF	12x12x6x6	7-1/2	9-3/4	13-3/4	13	27-1/2	26	14-1/8	7-1/2	57.20	61.56
820-668F	820-668CF	12x12x8x8	8-3/4	11	15	15-1/4	30	30-1/2	14-1/4	9-5/8	66.12	73.35
820-670F	820-670CF	12x12x10x10	9-5/8	10-1/2	15-7/8	15-3/4	31-3/4	31-1/2	14-1/8	12	105.91	78.03
820-691F	820-691CF	14x14x2x2	4-1/8	7-3/8	11-1/8	8-7/8	22-1/4	17-3/4	15-1/2	2-15/16	38.49	45.02
820-693F	820-693CF	14x14x3x3	4-5/8	7-1/2	11-5/8	9-3/8	23-1/4	18-3/4	15-1/2	4-1/4	49.59	57.57

¹ Outlet sized with bushing

PVC & CPVC SCHEDULE 80 FITTINGS, UNIONS, TANK ADAPTERS, EXPANSION JOINTS & SADDLES

REDUCING CROSS (continued)

Soc x Soc x Soc x Soc

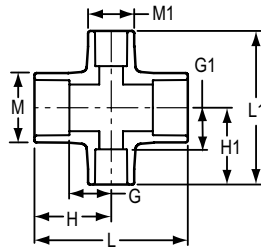

Part Number		Size	G	G1	H	H1	L	L1	M	M1	Approx. Wt. (Lbs.)	
PVC	CPVC										PVC	CPVC
820-694F	820-694CF	14x14x4x4	4-5/8	7-1/2	11-5/8	9-3/4	23-1/4	19-1/2	15-1/2	5-5/16	43.51	69.17
820-696F	820-696CF	14x14x6x6	8-1/4	10-3/8	15-1/4	13-5/8	30-1/2	27-1/4	15-1/2	7-1/2	78.72	63.15
820-698F	820-698CF	14x14x8x8	9-1/4	11-1/4	16-1/4	15-1/2	32-1/2	31	15-1/2	9-5/8	75.53	68.17
820-700F	820-700CF	14x14x10x10	10-1/8	11-1/2	17-1/8	16-3/4	34-1/4	33-1/2	15-1/2	11-15/16	95.66	89.80
820-702F	820-702CF	14x14x12x12	11	11-1/4	8	17-1/2	36	35	15-1/2	14-1/8	98.88	93.81
820-751F	---	16x16x2x2	6-5/8	10-1/16	14-5/8	11-13/16	29-1/4	23-5/8	17-5/8	2-7/8	55.64	---
820-753F	820-753CF	16x16x3x3	4-1/2	8-1/2	12-1/2	10-3/8	25	20-3/4	17-11/16	4-1/4	58.72	67.39
820-754F	820-754CF	16x16x4x4	5	8-1/2	13	10-3/4	26	21-1/2	17-3/4	5-3/16	61.59	70.21
820-756F	820-756CF	16x16x6x6	8-5/8	11-1/2	16-5/8	14-3/4	33-1/4	29-1/2	17-11/16	7-1/2	93.13	90.09
820-758F	---	16x16x8x8	9-5/8	12-1/4	17-5/8	16-1/2	35-1/4	33	17-5/8	9-5/8	91.88	---
820-760F	---	16x16x10x10	10-5/8	12-1/8	18-5/8	17-3/8	37-1/4	34-3/4	17-5/8	12	104.59	---
820-762F	---	16x16x12x12	11-5/8	12	19-5/8	18-1/4	39-1/4	36-1/2	17-5/8	14-1/8	141.98	---
820-764F	820-764CF	16x16x14x14	20-3/4	13-1/4	20-3/4	20-1/4	41-1/2	40-1/2	17-5/8	15-1/2	129.00	135.00
820-784F	---	18x18x4x4	7-1/2	12-1/4	16-1/2	14-1/2	33	29	20	5-1/4	92.66	---
820-786F	820-786CF	18x18x6x6	8-1/2	12-1/2	17-1/2	15-3/4	35	31-1/2	19-7/8	7-1/2	118.63	122-13
820-788F	---	18x18x8x8	9-1/2	13-1/4	18-1/2	17-1/2	37	35	20	9-5/8	128.81	---
820-790F	820-790CF	18x18x10x10	10-1/2	13-1/4	19-1/2	18-1/2	39	37	19-7/8	11-15/16	130.87	150.90
820-792F	820-792CF	18x18x12x12	20-1/2	11-1/2	20-1/2	19-1/4	41	38-1/2	19-7/8	14-1/8	147.26	169.57
820-794F	820-794CF	18x18x14x14	11-1/2	13-7/16	20-1/2	20-7/16	41	40-7/8	19-7/8	15-1/2	164.25	165.78
820-796F	820-796CF	18x18x16x16	13-1/2	13-3/4	22-1/2	21-3/4	45	43-1/2	19-7/8	17-11/16	189.00	172.46
820-814F	---	20x20x4x4	7-7/8	13-3/4	17-7/8	16	35-3/4	31-7/8	22-1/8	5-1/4	115.50	---
820-816F	---	20x20x6x6	8-7/8	13-5/8	18-7/8	16-7/8	37-3/4	33-5/8	22-1/8	7-1/2	133.63	---
820-818F	---	20x20x8x8	9-7/8	14-1/4	19-7/8	18-1/2	39-3/4	37	22-1/8	9-5/8	153.30	---
820-820F	---	20x20x10x10	10-7/8	14-1/8	20-7/8	19-3/8	41-3/4	38-3/4	22-1/8	12	168.43	---
820-822F	---	20x20x12x12	11-7/8	14-3/8	21-7/8	20-5/8	43-3/4	41-1/4	22-1/8	14-1/4	186.06	---
820-824F	---	20x20x14x14	12-7/8	14-7/8	22-7/8	21-7/8	45-3/4	43-3/4	22-1/8	15-5/8	204.39	---
820-826F	---	20x20x16x16	13-7/8	15-5/8	23-7/8	23-5/8	47-3/4	47-1/4	22-1/8	17-3/4	230.10	---
820-828F	---	20x20x18x18	14-7/8	15-1/2	24-7/8	24-1/2	49-3/4	48-7/8	22-1/8	20	258.28	---
820-904F	---	24x24x4x4	9-1/4	15-5/8	20-1/4	17-7/8	40-1/2	35-7/8	26-1/2	5-1/4	192.22	---
820-906F	---	24x24x6x6	9-1/4	15-1/8	21-1/4	18-3/8	42-1/2	36-3/4	26-7/16	7-1/2	211.33	---
820-908F	---	24x24x8x8	10-1/4	10-1/4	22-1/4	20-3/8	44-1/2	40-3/4	26-7/16	9-5/8	221.76	---
820-910F	---	24x24x10x10	12-1/4	16-1/8	23-1/4	21-3/8	46-1/2	42-3/4	26-1/2	12	249.91	---
820-912F	---	24x24x12x12	13-1/4	16-3/8	24-1/4	22-5/8	48-1/2	45-1/4	26-1/2	14-1/4	279.88	---

PVC & CPVC SCHEDULE 80 FITTINGS, UNIONS, TANK ADAPTERS, EXPANSION JOINTS & SADDLES

REDUCING CROSS

Soc x Soc x Soc x Soc

(continued)

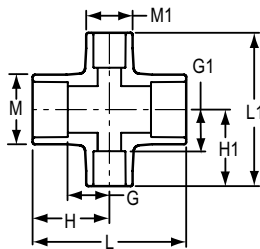

Part Number		Size	G	G1	H	H1	L	L1	M	M1	Approx. Wt. (Lbs.)	
PVC	CPVC										PVC	CPVC
820-914F	---	24x24x14x14	14-1/4	16-7/8	25-1/4	23-7/8	50-1/2	47-3/4	26-1/2	15-5/8	301.05	---
820-918F	---	24x24x18x18	16-1/4	17-1/2	27-1/4	26-1/2	54-1/2	52-7/8	26-1/2	20	360.62	---
820-920F	---	24x24x20x20	17-1/4	18-1/8	28-1/4	28-1/8	56-1/2	56-1/4	26-1/2	22-1/8	398.22	---

COUPLING

Soc x Soc

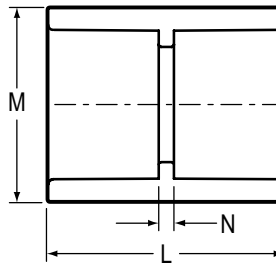

Part Number		Size	L	M	N	Approx. Wt. (Lbs.)	
PVC	CPVC					PVC	CPVC
829-002	829-002C	1/4	1-3/8	27/32	1/16	.02	.02
829-003	829-003C	3/8	1-5/8	1	3/16	.04	.04
829-005	829-005C	1/2	1-7/8	1-3/16	1/8	.07	.07
829-007	829-007C	3/4	2-1/8	1-13/32	1/8	.10	.10
829-010	829-010C	1	2-3/8	1-23/32	1/8	.12	.16
829-012	829-012C	1-1/4	2-23/32	2-7/32	7/32	.22	.24
829-015	829-015C	1-1/2	2-7/8	2-11/32	3/16	.20	.32
829-020	829-020C	2	3-1/8	2-7/8	1/16	.31	.33
829-025	829-025C	2-1/2	3-11/16	3-15/32	1/4	.55	.58
829-030	829-030C	3	4	4-3/16	3/16	.82	.90
829-040	829-040C	4	4-3/4	5-5/16	1/4	1.34	1.36
829-050	829-050C	5	5-1/2	6-3/8	3/16	2.01	2.19
829-050F	829-050CF	5	7-3/8	6-5/16	1-3/8	2.60	2.32
829-060	829-060C	6	6-1/4	7-11/16	1/4	3.32	3.77
829-080	829-080C	8	8-7/16	9-11/16	5/16	6.61	6.87
829-100	829-100C	10	10-1/4	12	1/4	11.27	12.11
829-100F	829-100CF	10	12-1/2	11-13/16	2	13.94	16.78
829-120	829-120C	12	12-3/8	14-1/4	3/8	18.99	19.98

PVC & CPVC SCHEDULE 80 FITTINGS, UNIONS, TANK ADAPTERS, EXPANSION JOINTS & SADDLES

COUPLING

Soc x Soc

(continued)

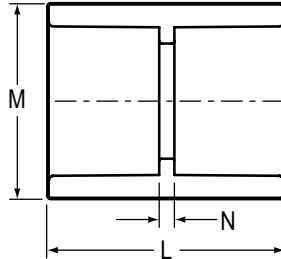

Part Number		Size	L	M	N	Approx. Wt. (Lbs.)	
PVC	CPVC					PVC	CPVC
829-120F	829-120CF	12	14-1/4	14-1/8	2	21.92	27.71
829-140	829-140C	14	14-7/16	15-5/8	3/8	29.70	28.11
829-140F	829-140CF	14	16-1/4	15-1/2	2-1/4	29.70	33.33
829-160F	829-160CF	16	18-5/8	17-11/16	2-5/8	42.38	42.93
829-180F	---	18	21-1/4	19-7/8	3-1/4	63.81	---
829-200F	---	20	24-1/4	22-1/16	4-1/4	86.58	---
829-240F	---	24	28	26-5/8	4	147.22	---

REDUCER COUPLING

Soc x Soc

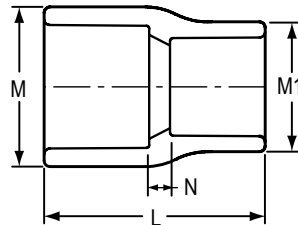

Part Number		Size	L	M	M1	N	Approx. Wt. (Lbs.)	
PVC	CPVC						PVC	CPVC
829-101	829-101C	3/4x1/2	1-31/32	1-13/32	1-3/16	7/32	.06	.07
829-130	829-130C	1x1/2	2-3/16	1-23/32	1-13/32	7/32	.11	.12
829-131	829-131C	1x3/4	2-13/32	1-23/32	1-13/32	1/4	.10	.10
829-166	829-166C	1-1/4x1/2	2-1/4	2-1/16	1-5/32	1/8	.14	.15
829-167	829-167C	1-1/4x3/4	2-19/32	2-3/32	1-5/8	3/8	.17	.18
829-168	829-168C	1-1/4x1	2-23/32	2-3/32	1-23/32	3/8	.17	.15
829-209	829-209C	1-1/2x1/2	2-27/32	2-11/32	1-3/16	19/32	.19	.20
829-210	829-210C	1-1/2x3/4	2-7/8	2-3/8	1-13/32	17/32	.18	.19
829-211	829-211C	1-1/2x1	2-7/8	2-11/32	1-15/16	3/8	.23	.25
829-212	829-212C	1-1/2x1-1/4	2-13/16	2-3/8	2-3/32	5/32	.21	.22
829-247	829-247C	2x1/2	3-3/32	2-7/8	1-3/16	3/4	.29	.31
829-248	829-248C	2x3/4	3-7/32	2-7/8	1-13/32	23/32	.30	.32
829-249	829-249C	2x1	3-1/8	2-7/8	1-23/32	17/32	.28	.30
829-250	829-250C	2x1-1/4	3-11/32	2-7/8	2-3/32	19/32	.31	.33
829-251	829-251C	2x1-1/2	3-7/32	2-27/32	2-11/32	7/32	.30	.31

PVC & CPVC SCHEDULE 80 FITTINGS, UNIONS, TANK ADAPTERS, EXPANSION JOINTS & SADDLES

REDUCER COUPLING (continued)

Soc x Soc

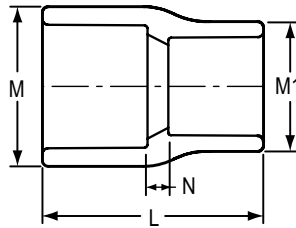

Part Number		Size	L	M	M1	N	Approx. Wt. (Lbs.)	
PVC	CPVC						PVC	CPVC
829-291	829-291C	2-1/2x1-1/2	3-1/2	2-11/32	9/16	3-11/16	.51	.51
829-292	829-292C	2-1/2x2	3-21/32	3-15/32	2-27/32	13/32	.48	.51
829-335	829-335C	3x1	4-7/16	4-1/8	2-7/8	1-7/16	1.00	---
829-337 ¹	829-337C ¹	3x1/2	4-13/32	4-5/32	2-7/8	1-3/16	.94	.96
829-338	829-338C	3x2	4	4-5/32	2-27/32	11/16	.68	.76
829-339 ¹	829-339C ¹	3x2-1/2	4-9/32	4-7/32	4-7/32	5/16	1.26	1.31
829-416 ¹	829-416C ¹	4x3/4	5-1/8	5-9/32	2-7/8	1-7/8	1.42	1.60
829-417 ¹	829-417C ¹	4x1	5-1/8	5-9/32	2-29/32	1-23/32	1.45	1.54
829-419 ¹	829-419C ¹	4x1-1/2	5-3/16	5-9/32	2-29/32	2-9/16	1.37	1.56
829-420	829-420C	4x2	4-5/8	5-9/32	2-7/8	13/16	1.20	1.27
829-421	829-421C	4x2-1/2	4-9/16	5-3/16	3-1/2	17/32	1.25	1.35
829-422	829-422C	4x3	4-5/8	5-1/4	4-1/8	1/2	1.25	1.33
829-424F	---	4-1/2x4	6-13/16	5-5/8	5-1/4	2-1/16	1.97	---
829-488F	829-488CF	5x3	8-3/8	6-5/16	5-3/16	3-5/8	3.08	3.13
829-490F	829-490CF	5x4	7-13/16	6-1/4	5-3/16	2-5/8	2.09	2.53
829-491F	---	5x4-1/2	7-1/2	6-5/16	5-11/16	2-1/4	3.22	---
829-528 ¹	829-528C ¹	6x2	7-1/16	7-1/2	5	2-9/16	4.37	4.42
829-529 ¹	829-529C ¹	6x2-1/2	7-1/2	7-1/2	5	2-1/2	4.52	4.72
829-530 ¹	829-530C ¹	6x3	7-1/8	7-9/16	5-9/32	2-1/4	4.07	4.25
829-530F	829-530CF	6x3	11-3/4	7-5/16	4-1/8	6-1/4	3.92	4.29
829-532	829-532C	6x4	6-5/8	7-5/8	5-5/16	1-7/16	3.	3.45
829-534F	---	6x4-1/2	9	7-3/8	5-11/16	3-1/4	3.22	---
829-533F	829-533CF	6x5	8-3/4	7-3/8	6-5/16	2-1/2	3.57	---
829-580F	---	8x3	15	9-1/2	5-3/16	8-3/4	8.04	---
---	829-582C ¹	8x4	9-1/32	9-3/4	7-1/4	2-7/32	---	9.52
829-582F	829-582CF	8x4	14-1/2	9-1/2	5-3/16	8	8.17	9.36
829-585	829-585C	8x6	8	9-3/4	7-1/2	1	6.16	6.48
829-623F	---	10x3	22	11-3/4	5-3/16	14-3/4	15.77	---
829-624F	829-624CF	10x4	21-1/4	11-3/4	5-3/16	13-3/4	17.13	16.54
829-626F	829-626CF	10x6	18-1/4	11-3/4	7-1/2	9-3/4	14.72	15.00
829-628F	829-628CF	10x8	13-1/2	11-3/4	9-5/8	4	11.42	13.52
829-664F	829-664CF	12x4	25-5/16	13-15/16	7-1/2	17-1/16	31.70	32.77
829-666F	829-666CF	12x6	24-1/2	13-15/16	7-1/2	15	26.96	25.86
829-668F	829-668CF	12x8	20	13-15/16	9-5/8	9-1/2	24.34	24.34

¹ Outlet sized with bushing

PVC & CPVC SCHEDULE 80 FITTINGS, UNIONS, TANK ADAPTERS, EXPANSION JOINTS & SADDLES

REDUCER COUPLING

(continued)

Soc x Soc

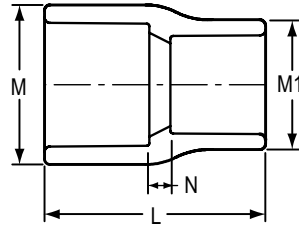

Part Number		Size	L	M	M1	N	Approx. Wt. (Lbs.)	
PVC	CPVC						PVC	CPVC
829-694F	---	14x4	30-3/8	15-1/4	5-1/4	21-1/8	31.56	---
829-696F	---	14x6	27-3/8	15-1/4	7-1/2	17-1/8	29.65	---
829-700F	829-700CF	14x10	18-3/8	15-1/4	12	6-1/8	22.90	26.86
829-702F	829-702CF	14x12	17-3/4	15-3/8	14-1/8	4-1/2	27.40	29.14
829-754F	---	16x4	38-5/8	17-1/2	5-1/4	28-3/8	50.97	---
829-756F	---	16x6	35-1/8	17-1/2	7-1/2	23-7/8	61.19	---
829-758F	829-758CF	16x8	32-1/4	17-1/2	9-5/8	20	52.73	54.00
829-760F	---	16x10	26	17-3/8	12	12-3/4	43.70	---
829-762F	829-762CF	16x12	20-1/4	17-3/8	14-1/8	6	34.25	65.63
829-764F	829-764CF	16x14	21-1/2	17-5/8	15-5/8	6-1/2	42.89	50.00
829-784F	---	18x4	47-1/8	19-3/4	5-1/4	35-7/8	104.77	---
829-786F	---	18x6	44-7/8	19-3/4	7-1/2	32-5/8	91.02	---
829-788F	---	18x8	41-1/8	19-3/4	9-5/8	27-7/8	86.65	---
829-790F	---	18x10	36-1/4	19-3/4	12	22	91.28	---
829-792F	---	18x12	29-3/4	19-3/4	14-1/8	14-1/2	73.27	---
829-794F	829-794CF	18x14	28-1/2	19-11/16	15-1/2	12-1/2	73.72	87.00
829-796F	---	18x16	22-5/8	19-3/4	17-3/4	5-5/8	55.09	---
829-814F	---	20x4	58-1/8	21-7/8	5-1/4	46-1/8	152.76	---
829-816F	---	20x6	54-3/8	21-7/8	7-1/2	41-1/8	136.93	---
829-818F	---	20x8	50-3/8	21-7/8	9-5/8	36-1/8	144.26	---
829-820F	---	20x10	46-1/2	21-7/8	11-15/16	31-1/4	139.44	---
829-822F	---	20x12	40-3/8	21-7/8	14-1/8	24-3/8	119.04	---
829-824F	---	20x14	39-5/8	21-7/8	15-1/2	22-5/8	118.17	---
829-826F	---	20x16	33-1/4	21-7/8	17-3/4	15-1/4	100.87	---
829-828F	---	20x18	24-7/8	21-7/8	19-7/8	5-7/8	79.76	---
829-904F	---	24x4	72-3/8	26	5-1/4	57-7/8	231.96	---
829-906F	---	24x6	68-7/8	26	7-1/2	53-1/8	229.16	---
829-908F	---	24x8	65-5/8	26	9-5/8	48-7/8	223.42	---
829-910F	---	24x10	60	26	12	42-1/4	218.80	---
829-912F	---	24x12	54-7/8	29-1/8	14-1/8	36-3/8	231.41	---
829-914F	---	24x14	55-5/8	26-1/8	15-1/2	36-1/8	225.10	---
829-916F	---	24x16	47-1/2	26	17-3/4	27	171.54	---
829-918F	---	24x18	38-3/4	26-1/8	19-7/8	17-1/4	147.20	---
829-920F	---	24x20	30-7/8	26-1/8	22-1/8	8-3/8	116.56	---

PVC & CPVC SCHEDULE 80 FITTINGS, UNIONS, TANK ADAPTERS, EXPANSION JOINTS & SADDLES

ECCENTRIC REDUCER COUPLING

Soc x Soc

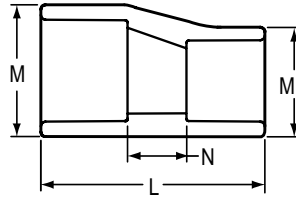

Part Number		Size	L	M	M1	N	Approx. Wt. (Lbs.)	
PVC	CPVC						PVC	CPVC
829-249FE	829-249CFE	2x1	5-7/8	2-13/16	1-3/4	2-7/8	0.37	0.37
829-335FE	829-335CFE	3x1	12-11/16	4	1-11/16	9-11/16	1.17	1.58
829-338FE	829-338CFE	3x2	8-1/8	3-15/16	2-13/16	4-1/8	0.93	0.99
829-420FE	829-420CFE	4x2	14-1/4	5-1/8	2-7/8	10-1/4	2.83	2.47
829-422FE	829-422CFE	4x3	8-1/2	5-1/8	4-1/8	4	1.70	2.04
829-528FE	829-528CFE	6x2	23-1/4	7-3/8	2-7/8	18-1/4	5.86	7.02
829-530FE	829-530CFE	6x3	18-1/4	7-3/8	4-1/8	12-3/4	6.24	6.16
829-532FE	829-532CFE	6x4	13-1/2	7-3/8	5-1/4	8	4.28	4.43
829-580FE	829-580CFE	8x3	28-3/4	9-5/8	4-1/8	22-1/4	11.13	16.42
829-582FE	829-582CFE	8x4	23	9-1/2	5-3/16	16-1/2	11.54	13.59
829-585FE	829-585CFE	8x6	15-1/2	9-5/8	7-1/2	8	8.41	9.78
829-624FE	829-624CFE	10x4	24-3/4	11-3/4	5-1/4	17-1/4	25.43	29.89
829-626FE	829-626CFE	10x6	26-3/8	11-3/4	7-1/2	17-7/8	22.31	25.59
829-628FE	829-628CFE	10x8	18-1/4	11-3/4	9-5/8	8-3/4	14.78	17.28
829-664FE	829-664CFE	12x4	45-1/4	13-15/16	7-1/2	36-3/4	42.54	56.73
829-666FE	829-666CFE	12x6	38	13-15/16	7-1/2	28-1/2	35.33	52.43
829-668FE	829-668CFE	12x8	28-1/2	14	9-5/8	18	32.68	34.80
829-670FE	829-670CFE	12x10	20-1/2	13-15/16	11-15/16	9	24.89	29.09
829-700FE	829-700CFE	14x10	30-1/8	15-3/8	11-15/16	17-7/8	51.42	60.41
829-702FE	829-702CFE	14x12	19-3/4	15-1/2	14-1/8	6-1/2	38.35	41.52

PVC & CPVC SCHEDULE 80 FITTINGS, UNIONS, TANK ADAPTERS, EXPANSION JOINTS & SADDLES

FABRICATED REPAIR COUPLING

Gasket x Gasket

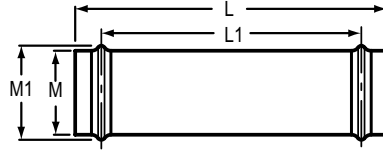

Part Number PVC	Size	L	L1	M	M1	Approx. Wt. (Lbs.)
828-040F	4	19-1/2	16-1/4	5-1/4	5-7/8	5.82
828-060F	6	23	18-1/2	7-1/2	8-7/16	12.61
828-080F	8	26-5/8	22-1/4	9-3/4	10-1/2	21.39
828-100F	10	29	21	10-3/4	12-1/4	32.98
828-120F	12	30	22-1/2	14-1/8	16-1/8	46.66
828-140F	14	19	11-1/2	15-1/2	17-1/2	39.40
828-160F	16	22	14-1/2	17-3/4	19-3/4	57.20

COUPLING

Fipt x Fipt

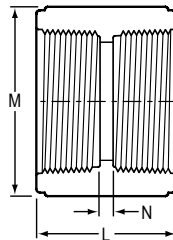

Part Number		Size	L	M	N	Approx. Wt. (Lbs.)	
PVC	CPVC					PVC	CPVC
830-002	830-002C	1/4	1-11/32	27/32	5/32	.02	.02
830-003	830-003C	3/8	1-15/32	1	9/32	.04	.04
830-005	830-005C	1/2	1-5/8	1-9/32	1/4	.07	.07
830-007	830-007C	3/4	1-11/16	1-17/32	1/16	.09	.09
830-010	830-010C	1	2-3/32	1-15/16	1/8	.15	.15
830-012	830-012C	1-1/4	2-3/16	2-3/16	1/8	.20	.22
830-015	830-015C	1-1/2	2-1/4	2-17/32	5/16	.28	.30
830-020	830-020C	2	2-7/32	3	7/32	.33	.35
830-025	830-025C	2-1/2	3-5/16	3-9/16	1/8	.68	.71
830-030	830-030C	3	3-1/2	4-3/8	11/16	1.06	1.12
830-040	830-040C	4	3-21/32	5-13/32	7/32	1.49	1.61
830-060F	830-060CF	6	6	7-1/4	3	2.69	2.96
830-080F	830-080CF	8	7-3/8	9-3/8	3-15/16	4.98	6.79

PVC & CPVC SCHEDULE 80 FITTINGS, UNIONS, TANK ADAPTERS, EXPANSION JOINTS & SADDLES

SPECIAL REINFORCED COUPLING

SR Fipt x SR Fipt

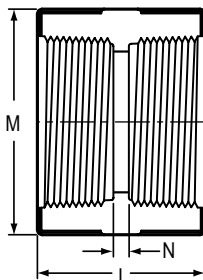

Part Number		Size	L	M	N	Approx. Wt. (Lbs.)	
PVC	CPVC					PVC	CPVC
830-005SR	830-005CSR	1/2	1-19/32	1-7/32	9/32	.06	.06
830-007SR	830-007CSR	3/4	1-5/8	1-3/8	1/8	.07	.07
830-010SR	830-010CSR	1	1-31/32	1-23/32	9/32	.13	.13
830-012SR	830-012CSR	1-1/4	2-1/16	2-1/16	5/16	.17	.17
830-015SR	830-015CSR	1-1/2	2-5/32	2-7/16	11/32	.27	.25
830-020SR	830-020CSR	2	2-1/4	3-1/32	1/4	.37	.39

REDUCER COUPLING

Fipt x Fipt

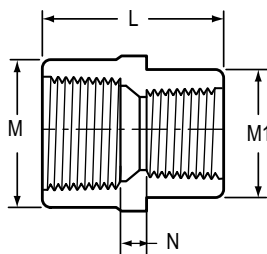

Part Number		Size	L	M	M1	N	Approx. Wt. (Lbs.)	
PVC	CPVC						PVC	CPVC
830-211 ¹	---	1-1/2x1	2-7/8	2-11/32	2-11/32	1-1/32	.35	---

¹ Outlet sized with bushing

PVC & CPVC SCHEDULE 80 FITTINGS, UNIONS, TANK ADAPTERS, EXPANSION JOINTS & SADDLES

SPECIAL REINFORCED REDUCER COUPLING

SR Fipt x SR Fipt

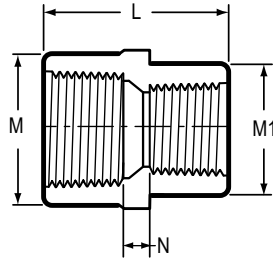

Part Number		Size	L	M	M1	N	Approx. Wt. (Lbs.)	
PVC	CPVC						PVC	CPVC
830-130SR	830-130CSR	1x1/2	2-1/4	1-23/32	1-7/32	21/32	.16	.17
830-131SR	830-131CSR	1x3/4	2-13/32	1-23/32	1-3/8	17/32	.16	.17
830-210SR	830-210CSR	1-1/2x3/4	2-7/8	2-7/16	1-3/8	1-7/32	.28	.29
830-211SR	830-211CSR	1-1/2x1	2-15/16	2-7/16	1-11/16	7/16	.35	.36
830-212SR	830-212CSR	1-1/2x1-1/4	2-7/8	2-1/2	2-3/32	15/16	.33	.34
830-249SR	830-249CSR	2x1	3-3/16	3	1-23/32	1-17/32	.46	.48
830-251SR	830-251CSR	2x1-1/2	3-1/4	3	2-7/16	1-7/16	.43	.52

GROOVED COUPLING ADAPTER

Groove x Soc

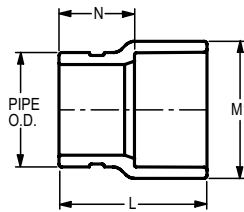

Part Number		Size	L	M1	N	Approx. Wt. (Lbs.)	
PVC	CPVC					PVC	CPVC
833-012	833-012C	1-1/4	2-13/16	2-1/16	1-9/16	.16	.17
833-015	833-015C	1-1/2	2-7/8	2-11/32	1-15/32	.19	.20
833-020	833-020C	2	3-1/16	2-7/8	1-9/16	.29	.30
833-025	833-025C	2-1/2	3-3/8	3-1/2	1-5/8	.49	.52
833-030	833-030C	3	3-9/16	4-3/16	1-11/16	.68	.72
833-040	833-040C	4	4-17/32	5-1/4	2-9/32	1.28	1.38
833-060	833-060C	6	5-5/16	7-9/16	2-5/16	2.78	3.00

PVC & CPVC SCHEDULE 80 FITTINGS, UNIONS, TANK ADAPTERS, EXPANSION JOINTS & SADDLES

FEMALE ADAPTER

Soc x Fipt

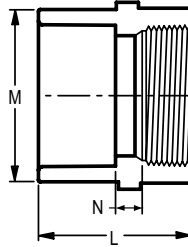

Part Number		Size	L	M	N	Approx. Wt. (Lbs.)	
PVC	CPVC					PVC	CPVC
835-002	835-002C	1/4	1-11/32	27/32	3/32	.02	.02
835-003	835-003C	3/8	1-15/32	1	3/32	.04	.04
835-005	835-005C	1/2	1-23/32	1-5/32	3/32	.05	.06
835-007	835-007C	3/4	1-27/32	1-13/32	1/32	.07	.08
835-010	835-010C	1	2-1/8	1-23/32	1/32	.11	.14
835-012	835-012C	1-1/4	2-3/8	2-1/4	1/8	.21	.22
835-015	835-015C	1-1/2	2-1/2	2-11/32	3/32	.19	.20
835-020	835-020C	2	2-11/16	3-1/32	1/8	.39	.41
835-025	835-025C	2-1/2	3-5/8	3-17/32	9/32	.70	.73
835-030	835-030C	3	3-25/32	4-1/4	9/32	.74	.76
835-040	835-040C	4	3-31/32	5-7/32	1/4	1.19	1.71
835-060	835-060C	6	7-7/8	7-1/2	2-15/16	2.90	3.02
835-080	835-080C	8	6-3/16	9-3/4	5/8	5.22	5.39
835-080F	835-080CF	8	8	9-5/8	1-7/8	6.19	6.56
835-100F	835-100CF	10	10-1/4	11-15/16	3-1/16	10.88	13.43
835-120F	835-120CF	12	11-1/8	14-1/8	2-1/4	16.56	20.00

PVC & CPVC SCHEDULE 80 FITTINGS, UNIONS, TANK ADAPTERS, EXPANSION JOINTS & SADDLES

SPECIAL REINFORCED FEMALE ADAPTER

Soc x SR Fipt

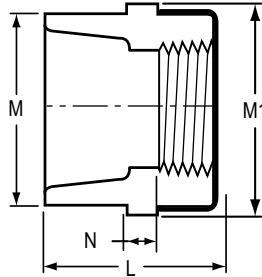

Part Number		Size	L	M	M1	N	Approx. Wt. (Lbs.)	
PVC	CPVC						PVC	CPVC
835-002SR	835-002CSR	1/4	1-13/32	13/16	7/8	5/32	.03	.03
835-003SR	835-003CSR	3/8	1-15/32	31/32	31/32	1/8	.04	.04
835-005SR	835-005CSR	1/2	1-3/4	1-3/16	1-3/16	3/16	.07	.07
835-007SR	835-007CSR	3/4	1-7/8	1-13/32	1-3/8	1/8	.08	.09
835-010SR	835-010CSR	1	2-5/32	1-3/4	1-11/16	1/8	.14	.13
835-012SR	835-012CSR	1-1/4	2-5/16	2-1/8	2-1/16	3/16	.19	.20
835-015SR	835-015CSR	1-1/2	2-7/16	2-13/32	2-7/16	7/32	.26	.28
835-020SR	835-020CSR	2	2-11/16	3	3	9/32	.43	.45
835-025SR	835-025CSR	2-1/2	3-1/4	3-9/16	3-9/16	11/32	.68	.70
835-030SR	835-030CSR	3	3-1/2	4-1/4	4-9/32	7/32	.96	1.01
835-040SR	835-040CSR	4	3-31/32	5-7/32	5-7/32	1/4	1.29	1.35
835-060SR	835-060CSR	6	5	7-1/2	7-11/16	3/4	3.04	3.16

TRANSITION FEMALE ADAPTER

Soc x Metal Fipt

Dimensions Applicable to 835-XXXSS

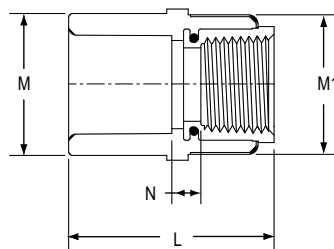

Part Number		Size	L	M	M1	N	Approx. Wt. (Lbs.)	
PVC	CPVC						PVC	CPVC
835-005BR	835-005CBR	1/2	1-25/32	1-7/32	1-7/32	11/32	.15	.16
835-007BR	835-007CBR	3/4	2	1-13/32	1-3/8	5/16	.23	.24
835-010BR	835-010CBR	1	2-9/32	1-23/32	1-23/32	11/32	.35	.37
835-012BR	835-012CBR	1-1/4	2-3/8	2-3/32	2-3/32	5/16	.30	.31
835-015BR	835-015CBR	1-1/2	2-17/32	2-3/8	2-7/16	1/4	.45	.46
835-020BR	835-020CBR	2	2-11/16	2-29/32	2-31/32	15/32	.57	.58

PVC & CPVC SCHEDULE 80 FITTINGS, UNIONS, TANK ADAPTERS, EXPANSION JOINTS & SADDLES

TRANSITION REDUCING FEMALE ADAPTER

Soc x Metal Fipt

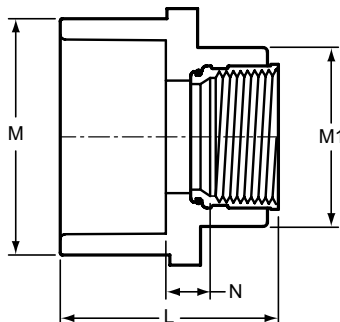

Part Number		Size	L	M	M1	N	Approx. Wt. (Lbs.)	
PVC	CPVC						PVC	CPVC
835-101BR	835-101CBR	3/4x1/2	1-15/16	1-7/16	1-3/16	5/16	.17	.17

SPECIAL REINFORCED REDUCING FEMALE ADAPTER

Soc x SR Fipt

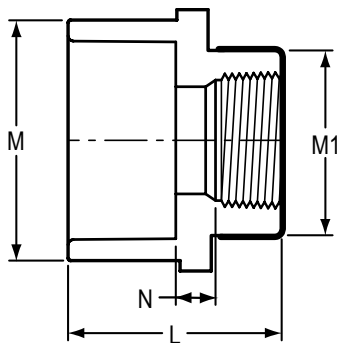

Part Number		Size	L	M	M1	N	Approx. Wt. (Lbs.)	
PVC	CPVC						PVC	CPVC
835-074SR	835-074CSR	1/2x3/4	1-3/4	1-3/16	1-3/8	7/32	.07	.08
835-101SR	835-101CSR	3/4x1/2	1-7/8	1-3/8	1-3/16	3/16	.07	.08
835-102SR	835-102CSR	3/4x1	2-1/16	1-7/16	1-11/16	7/32	.12	.13
835-130SR	835-130CSR	1x1/2	2	1-11/16	1-3/16	3/16	.11	.11
835-131SR	835-131CSR	1x3/4	2-3/32	1-3/4	1-3/8	1/4	.12	.13

PVC & CPVC SCHEDULE 80 FITTINGS, UNIONS, TANK ADAPTERS, EXPANSION JOINTS & SADDLES

ENCAPSULATED SPECIAL REINFORCED FEMALE ADAPTER

Soc x ESR Fipt

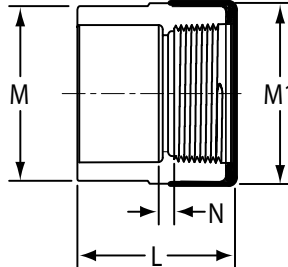

Part Number		Size	L	M	M1	N	Approx. Wt. (Lbs.)	
PVC	CPVC						PVC	CPVC
835-002ESR	835-002CESR	1/4	1-3/8	29/32	27/32	3/32	.03	.04
835-003ESR	835-003CESR	3/8	1-17/32	15/16	1-1/32	3/16	.04	.04
835-005ESR	835-005CSR	1/2	1-7/8	1-3/16	1-9/32	9/32	.08	.07
835-007ESR	835-007CESR	3/4	2	1-13/32	1-15/32	1/8	.10	.11
835-010ESR	835-010CESR	1	2-1/4	1-3/4	1-13/16	1/8	.13	.15
835-012ESR	835-012CESR	1-1/4	2-7/16	2-1/8	2-5/32	3/16	.21	.22
835-015ESR	835-015CESR	1-1/2	2-9/16	2-13/32	2-1/2	1/4	.29	.31
835-020ESR	835-020CESR	2	2-27/32	3	3-3/32	13/32	.46	.49

MALE ADAPTER

Spig x Mipt

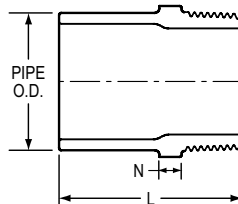

Part Number		Size	L	N	Approx. Wt. (Lbs.)	
PVC	CPVC				PVC	CPVC
861-005	861-005C	1/2	1-13/16	5/16	.03	.03
861-007	861-007C	3/4	1-31/32	5/16	.05	.05
861-010	861-010C	1	2-1/4	9/32	.07	.08
861-012	861-012C	1-1/4	2-7/16	9/32	.12	.13
861-015	861-015C	1-1/2	2-5/8	11/32	.15	.16
861-020	861-020C	2	2-13/16	13/32	.23	.24

PVC & CPVC SCHEDULE 80 FITTINGS, UNIONS, TANK ADAPTERS, EXPANSION JOINTS & SADDLES

SPECIAL REINFORCED SPIGOT FEMALE ADAPTER

Spig x SR Fipt

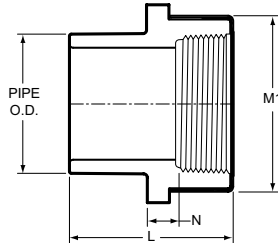

Part Number		Size	L	M1	N	Approx. Wt. (Lbs.)	
PVC	CPVC					PVC	CPVC
878-005SR	878-005CSR	1/2	1-3/4	1-7/32	5/32	.06	.06
878-007SR	878-007CSR	3/4	1-15/16	1-3/8	3/16	.07	.08
878-010SR	878-010CSR	1	2-1/4	1-11/16	7/32	.13	.13
878-012SR	878-012CSR	1-1/4	2-15/32	2-1/16	1/4	.18	.19
878-015SR	878-015CSR	1-1/2	2-21/32	2-7/16	9/32	.25	.26
878-020SR	878-020CSR	2	2-13/16	3-1/32	5/16	.37	.40
878-030SR	878-030CSR	3	3-13/16	4-9/32	17/32	.91	.97
878-040SR	878-040CSR	4	4-3/8	5-1/4	5/8	1.36	1.42

SPECIAL REINFORCED REDUCING SPIGOT FEMALE ADAPTER

Spig x SR Fipt

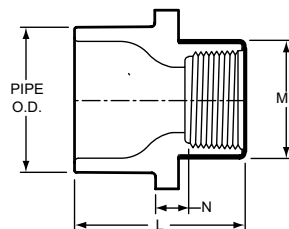

Part Number		Size	L	M1	N	Approx. Wt. (Lbs.)	
PVC	CPVC					PVC	CPVC
878-072SR	878-072CSR	1/2x1/4	1-13/32	27/32	3/16	.03	.03
878-098SR	878-098CSR	3/4x1/4	1-27/32	27/32	7/32	.05	.06
878-128SR	878-128CSR	1x1/4	2-3/8	27/32	21/32	.08	.09

PVC & CPVC SCHEDULE 80 FITTINGS, UNIONS, TANK ADAPTERS, EXPANSION JOINTS & SADDLES

ENCAPSULATED SPECIAL REINFORCED SPIGOT FEMALE ADAPTER

Spig x ESR Fipt

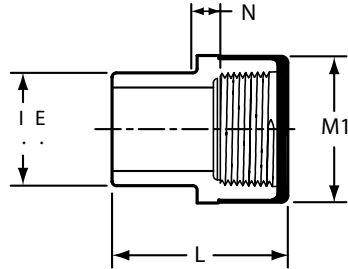

Part Number		Size	L	M1	N	Approx. Wt. (Lbs.)	
PVC	CPVC					PVC	CPVC
878-005ESR	878-005CESR	1/2	1-7/8	1-9/32	3/16	.06	.07
878-007ESR	878-007CESR	3/4	2-1/16	1-15/32	3/8	.09	.09
878-010ESR	878-010CESR	1	2-3/8	1-25/32	11/32	.14	.15
878-012ESR	878-012CESR	1-1/4	2-19/32	2-5/32	5/16	.20	.20
878-015ESR	878-015CESR	1-1/2	2-3/4	2-1/2	13/32	.27	.29
878-020ESR	878-020CESR	2	2-15/16	3-3/32	5/16	.41	.44

TRANSITION FEMALE ADAPTER

Spig x Metal Fipt

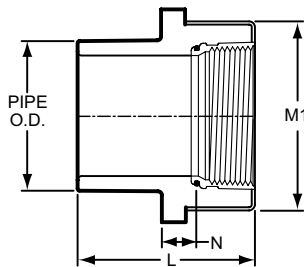

Part Number		Size	L	M1	N	Approx. Wt. (Lbs.)	
PVC	CPVC					PVC	CPVC
878-010BR	---	1	2-13/32	1-23/32	17/32	.24	---

PVC & CPVC SCHEDULE 80 FITTINGS, UNIONS, TANK ADAPTERS, EXPANSION JOINTS & SADDLES

MALE ADAPTER

Mipt x Soc

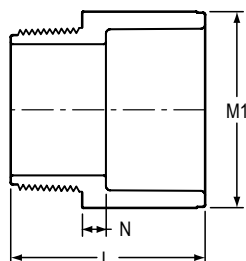

Part Number		Size	L	M1	N	Approx. Wt. (Lbs.)	
PVC	CPVC					PVC	CPVC
836-005	836-005C	1/2	1-13/16	1-3/16	3/16	.04	.05
836-007	836-007C	3/4	1-29/32	1-13/32	1/4	.06	.06
836-010	836-010C	1	2-3/16	1-3/4	9/32	.09	.12
836-012	836-012C	1-1/4	2-1/2	2-1/8	9/32	.15	.16
836-015	836-015C	1-1/2	2-17/32	2-3/8	13/32	.19	.20
836-020	836-020C	2	2-23/32	2-7/8	9/32	.27	.29
836-025	836-025C	2-1/2	3-1/2	3-17/32	13/32	.53	.57
836-030	836-030C	3	3-3/4	4-3/16	9/16	.75	.77
836-040	836-040C	4	4-3/8	5-3/16	1/2	1.13	1.22
836-050F	---	5	6	6-7/16	1-5/8	2.25	---
836-060	836-060C	6	5-7/16	7-1/2	13/16	2.79	3.07
836-080F	836-080CF	8	8-7/16	9-3/4	2-1/2	6.00	5.95
836-100F	836-100CF	10	10	11-15/16	2-5/8	10.95	10.95
836-120F	836-120CF	12	13-3/8	14-1/8	5-1/4	16.44	19.99

REDUCING MALE ADAPTER

Mipt x Soc

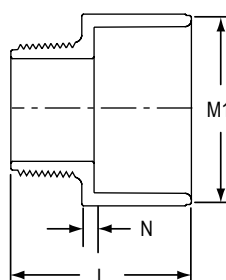

Part Number		Size	L	M1	N	Approx. Wt. (Lbs.)	
PVC	CPVC					PVC	CPVC
836-053	---	3/8x1/2	1-11/16	1-3/16	1/4	.04	---

PVC & CPVC SCHEDULE 80 FITTINGS, UNIONS, TANK ADAPTERS, EXPANSION JOINTS & SADDLES

REINFORCED MALE ADAPTER

Rmpt x Soc

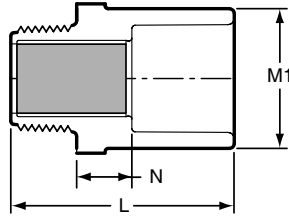

Part Number		Size	L	M1	N	Approx. Wt. (Lbs.)	
PVC	CPVC					PVC	CPVC
836-005R	836-005CR	1/2	2-3/32	1-5/32	9/16	.05	.06
836-007R	836-007CR	3/4	2-1/4	1-3/8	9/16	.08	.09
836-010R	836-010CR	1	2-21/32	1-23/32	11/16	.15	.15

REDUCER BUSHING

Flush Style

Spig x Soc

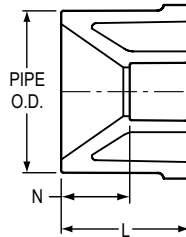

Part Number		Size	L	N	Approx. Wt. (Lbs.)	
PVC	CPVC				PVC	CPVC
837-052	837-052C	3/8x1/4	31/32	5/16	.01	.01
837-072	837-072C	1/2x1/4	7/8	7/8	.02	.02
837-073	837-073C	1/2x3/8	1-1/8	11/32	.01	.02
837-101	837-101C	3/4x1/2	1-1/8	3/8	.02	.03
837-129 ¹	837-129C ¹	1x3/8	1-5/8	27/32	.09	.10
837-130	837-130C	1x1/2	1-5/8	13/32	.05	.07
837-131	837-131C	1x3/4	1-3/8	3/8	.04	.04
837-166	837-166C	1-1/4x1/2	1-17/32	5/8	.11	.09
837-167	837-167C	1-1/4x3/4	1-7/16	7/16	.09	.12
837-168	837-168C	1-1/4x1	1-19/32	15/32	.08	.09
837-209	837-209C	1-1/2x1/2	1-23/32	13/16	.17	.18
837-210	837-210C	1-1/2x3/4	1-3/4	23/32	.19	.20
837-211	837-211C	1-1/2x1	1-17/32	13/32	.11	.15
837-212	837-212C	1-1/2x1-1/4	1-23/32	13/32	.07	.08
837-247	837-247C	2x1/2	1-29/32	1	.25	.30
837-248	837-248C	2x3/4	1-11/16	11/16	.26	.27

¹ Outlet sized with bushing

PVC & CPVC SCHEDULE 80 FITTINGS, UNIONS, TANK ADAPTERS, EXPANSION JOINTS & SADDLES

REDUCER BUSHING

(continued)

Flush Style

Spig x Soc

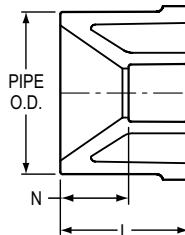

Part Number		Size	L	N	Approx. Wt. (Lbs.)	
PVC	CPVC				PVC	CPVC
837-249	837-249C	2x1	1-29/32	13/16	.26	.28
837-250	837-250C	2x1-1/4	1-11/16	7/16	.20	.23
837-251	837-251C	2x1-1/2	1-23/32	5/16	.14	.15
837-287 ¹	---	2-1/2X1/2	2-1/2	1-1/2	.54	---
837-288 ¹	---	2-1/2x3/4	2-17/32	1-15/32	.55	---
837-289	837-289C	2-1/2x1	2-11/16	1-5/8	.53	.53
837-290	837-290C	2-1/2x1-1/4	2-5/32	31/32	.43	.46
837-291	837-291C	2-1/2x1-1/2	2-13/32	1	.41	.43
837-292	837-292C	2-1/2x2	1-31/32	7/16	.21	.28
837-334 ¹	837-334C ¹	3x3/4	2-9/16	1-17/32	.71	.74
837-335	837-335C	3x1	2-1/4	1-3/16	.66	.70
837-336	837-336C	3x1-1/4	2-1/4	1	.63	.70
837-337	837-337C	3x1-1/2	2-1/4	7/8	.63	.67
837-338	837-338C	3x2	2-1/2	1	.61	.65
837-339	837-339C	3x2-1/2	2-5/16	9/32	.38	.41
837-417 ¹	---	4x1	3-1/16	1-1/8	1.31	---
837-418 ¹	837-418C ¹	4x1-1/4	3-9/16	1-11/16	1.33	1.38
837-419 ¹	---	4x1-1/2	4-7/8	3-7/16	1.23	---
837-420	837-420C	4x2	2-5/8	1-1/8	1.05	1.13
837-421 ¹	837-421C ¹	4x2-1/2	2-15/16	7/8	1.20	1.27
837-422	837-422C	4x3	2-11/16	13/16	.81	.86
837-490	---	5x4	2-27/32	9/16	1.20	---
837-490F	837-490CF	5x4	3-1/4	1	1.41	1.50
837-524 ¹	---	6x3/4	4-1/2	3-1/2	3.45	---
837-526 ¹	---	6x1-1/4	4-7/16	2-3/4	3.22	---
837-528	837-528C	6x2	3-9/32	1-25/32	2.52	2.64
837-530	837-530C	6x3	3-1/4	1-13/32	2.65	2.77
837-532	837-532C	6x4	4	1-23/32	2.03	3.04
837-533F	837-533CF	6x5	3-1/4	1/2	1.76	1.94
837-534	---	6x5	3-9/32	5/8	1.70	---
837-578 ¹	837-578C ¹	8x2	4-15/16	3-3/8	8.64	8.99
837-580 ¹	837-580C ¹	8x3	5-1/8	3-1/4	8.68	8.81

¹ Outlet sized with bushing

PVC & CPVC SCHEDULE 80 FITTINGS, UNIONS, TANK ADAPTERS, EXPANSION JOINTS & SADDLES

REDUCER BUSHING

(continued)

Flush Style

Spig x Soc

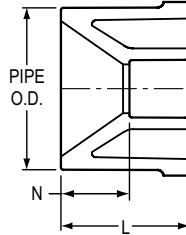

Part Number		Size	L	N	Approx. Wt. (Lbs.)	
PVC	CPVC				PVC	CPVC
837-582	837-582C	8x4	4-1/4	2-1/16	8.32	9.01
837-585	837-585C	8x6	4-1/4	1-5/16	5.40	5.15
837-624 ¹	837-624C ¹	10x4	6	3-3/4	10.56	11.36
837-626	837-626C	10x6	5-7/16	2-13/32	7.89	8.41
837-628	837-628C	10x8	6-7/16	1-15/16	6.23	10.84
837-666	---	12x6	7	4	15.51	---
837-666F	837-666CF	12x6	6-1/2	3	15.31	19.45
837-668	837-668C	12x8	6-7/8	2-7/16	9.78	10.95
837-670	837-670C	12x10	6-1/32	1-1/2	13.30	15.43
837-670F	837-670CF	12x10	6	3/4	11.04	11.78
837-696F	---	14x6	7-1/2	4-1/2	27.16	---
837-698F	837-698CF	14x8	7-1/2	3	32.31	32.02
837-700F	837-700CF	14x10	7-1/2	2-1/2	22.30	24.44
837-702F	---	14x12	7	1	9.36	---
837-756F	---	16x6	8-1/4	4-3/4	51.70	---
837-758F	---	16x8	8	4	46.90	---
837-760F	---	16x10	8-1/2	3-1/2	39.12	---
837-762F	---	16x12	8	2	28.08	---
837-764F	---	16x14	8	1	18.37	---
837-788F	---	18x8	9-3/4	5-1/4	70.33	---
837-790F	---	18x10	9	4	65.20	---
837-792F	---	18x12	9	3	49.70	---
837-794F	---	18x14	9	2	40.70	---
837-796F	---	18x16	9	1	24.10	---
837-818F	---	20x8	10	6	125.96	---
837-820F	---	20x10	10	5	94.18	---
837-822F	---	20x12	10	4	83.14	---
837-826F	---	20x16	10	2	55.07	---
837-828F	---	20x18	10	1	33.04	---
837-910F	---	24x10	12	6	173.68	---
837-912F	---	24x12	12	5	159.41	---
837-914F	---	24x14	12	4	80.35	---

¹ Outlet sized with bushing

PVC & CPVC SCHEDULE 80 FITTINGS, UNIONS, TANK ADAPTERS, EXPANSION JOINTS & SADDLES

REDUCER BUSHING

Flush Style

Spig x Soc

(continued)

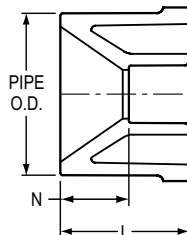

Part Number		Size	L	N	Approx. Wt. (Lbs.)	
PVC	CPVC				PVC	CPVC
837-916F	---	24x16	12	3	134.57	---
837-918F	---	24x18	12	2	112.54	---
837-920F	---	24x20	12	1	79.50	---

REDUCER BUSHING

Flush Style

Spig x Fipt

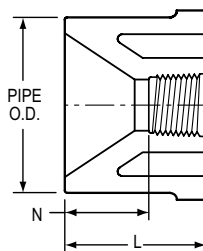

Part Number		Size	L	N	Approx. Wt. (Lbs.)	
PVC	CPVC				PVC	CPVC
838-052	838-052C	3/8x1/4	31/32	7/16	.01	.01
838-071	838-071C	1/2x1/8	1-3/32	11/16	.02	.02
838-072	838-072C	1/2x1/4	1-3/32	1/2	.02	.02
838-073	838-073C	1/2x3/8	1-3/32	17/32	.02	.02
838-098	838-098C	3/4x1/4	1-7/32	5/8	.04	.04
838-099	838-099C	3/4x3/8	1-1/4	21/32	.04	.04
838-101	838-101C	3/4x1/2	1-1/4	7/16	.03	.03
838-127	---	1x1/8	1-3/8	5/8	.07	---
838-129	838-129C	1x3/8	1-13/32	13/16	.07	.07
838-130	838-130C	1x1/2	1-7/16	11/16	.06	.06
838-131	838-131C	1x3/4	1-13/32	23/32	.05	.06
838-166	838-166C	1-1/4x1/2	1-17/32	13/16	.11	.12
838-167	838-167C	1-1/4x3/4	1-9/16	27/32	.11	.12
838-168	838-168C	1-1/4x1	1-17/32	5/8	.08	.09
838-206	---	1-1/2x1/8	1-11/16	1-1/4	.15	---

PVC & CPVC SCHEDULE 80 FITTINGS, UNIONS, TANK ADAPTERS, EXPANSION JOINTS & SADDLES

REDUCER BUSHING

Flush Style

Spig x Fipt

(continued)

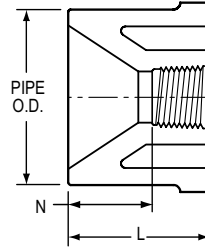

Part Number		Size	L	N	Approx. Wt. (Lbs.)	
PVC	CPVC				PVC	CPVC
838-207	---	1-1/2x1/4	1-17/32	15/16	.13	---
838-209	838-209C	1-1/2x1/2	1-11/16	15/16	.17	.17
838-210	838-210C	1-1/2x3/4	1-3/4	31/32	.17	.18
838-211	838-211C	1-1/2x1	1-11/16	13/16	.14	.16
838-212	838-212C	1-1/2x1-1/4	1-9/16	9/16	.07	.10
838-247	838-247C	2x1/2	1-29/32	1-1/8	.28	.26
838-248	838-248C	2x3/4	1-29/32	1-5/32	.26	.26
838-249	838-249C	2x1	1-29/32	1	.25	.27
838-250	838-250C	2x1-1/4	1-29/32	29/32	.23	.25
838-251	838-251C	2x1-1/2	1-29/32	7/8	.19	.20
838-287	838-287C	2-1/2x1/2	2-3/8	1-21/32	.41	.46
838-288	838-288C	2-1/2x3/4	2-7/16	1-5/8	.45	.48
838-289	838-289C	2-1/2x1	2-13/32	1-13/32	.45	.48
838-290	838-290C	2-1/2x1-1/4	2-13/32	1-3/8	.42	.45
838-291	838-291C	2-1/2x1-1/2	2-13/32	1-3/8	.47	.52
838-292	838-292C	2-1/2x2	2-13/32	1-3/8	.31	.33
838-334	838-334C	3x3/4	2-29/32	1-1/2	.57	.61
838-335	838-335C	3x1	2-1/4	1-3/8	.59	.62
838-336	838-336C	3x1-1/4	2-1/4	1-3/8	.57	.61
838-337	838-337C	3x1-1/2	2-1/4	1-5/8	.59	.62
838-338	838-338C	3x2	2-9/32	1-7/32	.63	.68
838-339	838-339C	3x2-1/2	2-13/32	27/32	.46	.50
838-419	---	4x1-1/2	3-3/16	2-5/16	1.44	---
838-420	838-420C	4x2	2-11/16	1-21/32	1.10	1.20
838-421	838-421C	4x2-1/2	2-21/32	1-1/8	1.08	1.10
838-422	838-422C	4x3	2-5/8	1	.86	.85
838-528	838-528C	6x2	3-1/4	2-9/32	2.61	2.80
838-530	838-530C	6x3	3-9/32	1-7/8	2.71	2.85
838-532	838-532C	6x4	3-1/2	2	2.54	3.00

PVC & CPVC SCHEDULE 80 FITTINGS, UNIONS, TANK ADAPTERS, EXPANSION JOINTS & SADDLES

SPECIAL REINFORCED REDUCER BUSHING

Flush Style

Spig x SR Fipt

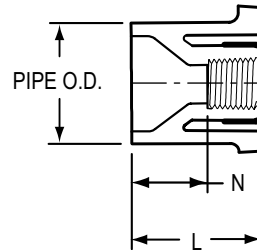

Part Number		Size	L	N	Approx. Wt. (Lbs.)	
PVC	CPVC				PVC	CPVC
838-128SR	838-128CSR	1x1/4	1-3/8	27/32	.06	.07
838-207SR	---	1-1/2x1/4	1-19/32	15/16	.13	---
838-209SR	838-209CSR	1-1/2x1/2	1-23/32	31/32	.12	.13
838-210SR	838-210CSR	1-1/2x3/4	1-21/32	31/32	.15	.15
838-247SR	838-247CSR	2x1/2	1-29/32	1-5/32	.25	.25
838-248SR	838-248CSR	2x3/4	1-29/32	1-5/32	.26	.26
838-249SR	828-249CSR	2x1	1-7/8	31/32	.26	.27
838-334SR	828-334CSR	3x3/4	2-1/4	1-1/2	.57	.62
838-335SR	838-335CSR	3x1	2-1/4	1-3/8	.58	.63
838-336SR	838-336CSR	3x1-1/4	2-1/4	1-5/16	.57	.63
838-337SR	838-337CSR	3x1-1/2	2-1/4	1-3/8	.58	.64
838-528SR	838-528CSR	6x2	3-5/16	2-9/32	2.60	2.72
838-530SR	838-530CSR	6x3	3-9/32	1-7/8	2.74	2.83
838-532SR	838-532CSR	6x4	3-1/2	1-15/16	2.59	2.62

REDUCER T.T. BUSHING

Flush Style

Mipt x Fipt

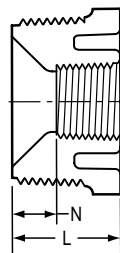

Part Number		Size	L	N	Approx. Wt. (Lbs.)	
PVC	CPVC				PVC	CPVC
839-052	839-052C	3/8x1/4	13/16	1/8	.01	.01
839-072	839-072C	1/2x1/4	29/32	9/32	.02	.02

PVC & CPVC SCHEDULE 80 FITTINGS, UNIONS, TANK ADAPTERS, EXPANSION JOINTS & SADDLES

REDUCER T.T. BUSHING

Flush Style

Mipt x Fipt

(continued)

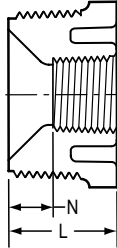

Part Number		Size	L	N	Approx. Wt. (Lbs.)	
PVC	CPVC				PVC	CPVC
839-073	839-073C	1/2x3/8	7/8	5/16	.01	.01
839-098	839-098C	3/4x1/4	1-1/32	7/16	.03	.04
839-099	839-099C	3/4x3/8	1-1/32	7/16	.03	.03
839-101	839-101C	3/4x1/2	15/16	7/32	.02	.02
839-128	839-128C	1x1/4	1-1/4	11/16	.06	.06
839-129	839-129C	1x3/8	1-1/4	11/16	.05	.06
839-130	839-130C	1x1/2	1-1/4	9/16	.06	.06
839-131	839-131C	1x3/4	1-1/4	15/32	.04	.04
839-166	839-166C	1-1/4x1/2	1-9/32	5/8	.10	.09
839-167	839-167C	1-1/4x3/4	1-9/32	5/8	.08	.09
839-168	839-168C	1-1/4x1	1-9/32	11/32	.06	.06
839-209	839-209C	1-1/2x1/2	1-7/32	1/2	.12	.13
839-210	839-210C	1-1/2x3/4	1-1/4	13/32	.10	.10
839-211	839-211C	1-1/2x1	1-11/32	1/2	.11	.11
839-212	839-212C	1-1/2x1-1/4	1-11/32	3/8	.07	.07
839-247	839-247C	2x1/2	1-11/32	5/8	.19	.20
839-248	839-248C	2x3/4	1-7/16	11/16	.18	.20
839-249	839-249C	2x1	1-5/16	1/2	.19	.20
839-250	839-250C	2x1-1/4	1-7/16	15/32	.16	.18
839-251	839-251C	2x1-1/2	1-7/16	7/16	.14	.14
839-292	839-292C	2-1/2x2	1-31/32	29/32	.24	.25
839-337	839-337C	3x1-1/2	2-1/32	1-1/16	.56	.61
839-338	839-338C	3x2	2-1/32	31/32	.51	.56
839-339	839-339C	3x2-1/2	2-1/32	15/32	.38	.41
839-420	839-420C	4x2	1-15/16	15/16	.78	.81
839-422	839-422C	4x3	2-1/8	1/2	.71	.74

PVC & CPVC SCHEDULE 80 FITTINGS, UNIONS, TANK ADAPTERS, EXPANSION JOINTS & SADDLES

SPECIAL REINFORCED

T.T. BUSHING

Mipt x SR Fipt

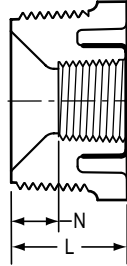

Part Number		Size	L	N	Approx. Wt. (Lbs.)	
PVC	CPVC				PVC	CPVC
839-209SR	839-209CSR	1-1/2x1/2	1-7/32	9/16	.11	.11
839-210SR	839-210CSR	1-1/2x3/4	1-7/32	1/2	.11	.11
839-247SR	839-247CSR	2x1/2	1-11/32	5/16	.20	.21
839-249SR	839-249CSR	2x1	1-5/16	1/2	.18	.20
839-420SR	839-420CSR	4x2	1-15/16	15/16	.84	.84

CAP

Soc

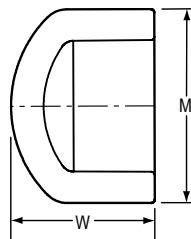

Part Number		Size	M	W	Approx. Wt. (Lbs.)	
PVC	CPVC				PVC	CPVC
847-002	847-002C	1/4	13/16	15/16	.01	.01
847-003	847-003C	3/8	31/32	1-5/32	.02	.02
847-005	847-005C	1/2	1-3/16	1-7/32	.03	.03
847-007	847-007C	3/4	1-3/8	1-13/32	.05	.05
847-010	847-010C	1	1-11/16	1-19/32	.08	.08
847-012	847-012C	1-1/4	2-3/32	1-27/32	.16	.13
847-015	847-015C	1-1/2	2-11/32	2	.16	.17
847-020	847-020C	2	2-27/32	2-9/32	.35	.37
847-025	847-025C	2-1/2	3-9/16	2-11/16	.50	.52
847-030	847-030C	3	4-5/32	3-1/32	.69	.93
847-040	847-040C	4	5-7/32	3-9/16	1.43	1.46
847-060	847-060C	6	7-1/2	4-7/8	3.17	3.22

PVC & CPVC SCHEDULE 80 FITTINGS, UNIONS, TANK ADAPTERS, EXPANSION JOINTS & SADDLES

CAP Soc (continued)

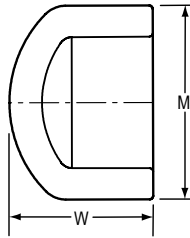

Part Number		Size	M	W	Approx. Wt. (Lbs.)	
PVC	CPVC				PVC	CPVC
847-080	847-080C	8	9-11/16	6-1/2	6.07	6.36
847-100F	847-100CF	10	12-1/4	6	8.26	9.12
847-120F	847-120CF	12	14-1/4	6-7/8	11.30	11.72
847-140F	847-140CF	14	15-9/16	8	14.65	16.54
847-160F	847-160CF	16	17-3/4	8-3/4	23.44	24.52
847-180F	---	18	19-7/8	9-1/4	28.88	---
847-200F	---	20	21-7/8	13	49.05	---
847-240F	---	24	26-1/2	18	69.76	---

CAP Fipt

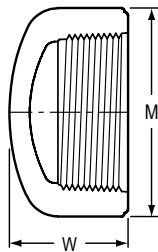

Part Number		Size	M	W	Approx. Wt. (Lbs.)	
PVC	CPVC				PVC	CPVC
848-002	848-002C	1/4	29/32	15/16	.02	.02
848-003	848-003C	3/8	31/32	29/32	.02	.02
848-005	848-005C	1/2	1-5/16	1-3/32	.04	.05
848-007	848-007C	3/4	1-17/32	1-7/32	.06	.06
848-010	848-010C	1	1-27/32	1-15/32	.10	.11
848-012	848-012C	1-1/4	2-7/32	1-17/32	.14	.15
848-015	848-015C	1-1/2	2-17/32	1-5/8	.19	.20
848-020	848-020C	2	3-5/32	1-25/32	.29	.30
848-025	848-025C	2-1/2	3-5/8	2-7/16	.54	.58
848-030	848-030C	3	4-3/8	2-7/16	.90	.94
848-040	848-040C	4	5-7/16	3-1/16	1.32	1.45
848-060F	848-060CF	6	7-1/4	4-3/8	2.07	6.18
848-080F	848-080CF	8	9-3/8	4-3/8	3.62	10.07

PVC & CPVC SCHEDULE 80 FITTINGS, UNIONS, TANK ADAPTERS, EXPANSION JOINTS & SADDLES

SPECIAL REINFORCED CAP

SR Fipt

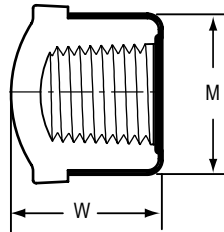

Part Number		Size	M	W	Approx. Wt. (Lbs.)	
PVC	CPVC				PVC	CPVC
848-002SR	848-002CSR	1/4	27/32	27/32	.02	.02
848-003SR	848-003CSR	3/8	31/32	29/32	.03	.03
848-030SR	848-030CSR	3	4-9/32	2-7/16	.79	.84

PLUG

Spig

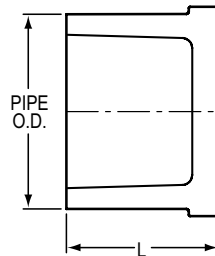

Part Number		Size	L	Approx. Wt. (Lbs.)	
PVC	CPVC			PVC	CPVC
849-005	---	1/2	1-5/32	.03	---
849-007	---	3/4	1-1/4	.04	---
849-010	849-010C	1	1-13/32	.06	.07
849-012	---	1-1/4	1-17/32	.10	---
849-015	---	1-1/2	1-11/16	.13	---
849-020	849-020C	2	1-7/8	.21	.24
849-030F	849-030CF	3	5-5/8	1.63	1.42
849-040F	849-040CF	4	6-1/2	2.76	3.00
849-060F	849-060CF	6	9-5/8	6.71	8.59

PVC & CPVC SCHEDULE 80 FITTINGS, UNIONS, TANK ADAPTERS, EXPANSION JOINTS & SADDLES

PLUG

Mipt

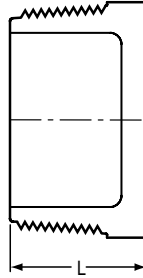

Part Number		Size	L	Approx. Wt. (Lbs.)	
PVC	CPVC			PVC	CPVC
850-002	850-002C	1/4	23/32	.01	.01
850-003	850-003C	3/8	13/16	.01	.01
850-005	850-005C	1/2	7/8	.02	.02
850-007	850-007C	3/4	7/8	.02	.03
850-010	850-010C	1	1-1/4	.06	.06
850-012	850-012C	1-1/4	1-9/32	.08	.08
850-015	850-015C	1-1/2	1-7/32	.10	.11
850-020	850-020C	2	1-7/16	.18	.20
850-025	850-025C	2-1/2	1-25/32	.30	.33
850-030	850-030C	3	1-7/8	.46	.50
850-040	850-040C	4	2-3/32	.73	.79
850-060	---	6	2-3/32	1.70	---
850-080F	850-080CF	8	10-1/4	11.45	12.39
850-100F	850-100CF	10	9-5/8	16.22	16.81

PVC & CPVC SCHEDULE 80 FITTINGS, UNIONS, TANK ADAPTERS, EXPANSION JOINTS & SADDLES

CLAMP-ON SADDLE x SOCKET SINGLE OUTLET

Dimensions Applicable to
866S-XXX 866V-XXX 866SV-XXX

2" - 4 235 psi @ 73°F
6" 200 psi @ 73°F
8" - 12" 150 psi @ 73°F

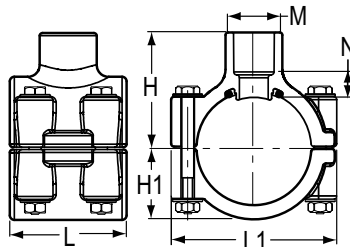

Part Number		Size	H	H1	L	L1	M	N	Approx. Wt. (Lbs.)	
PVC	CPVC								PVC	CPVC
866-247	866-247C	2x1/2	2-3/8	1-1/2	2-7/16	3-7/16	1-3/16	5/16	.56	.59
866-248	866-248C	2x3/4	2-1/2	1-1/2	2-7/16	3-7/16	1-3/8	5/16	.57	.60
866-249	866-249C	2x1	2-5/8	1-1/2	2-7/16	3-7/16	1-11/16	5/16	.40	.62
866-250	866-250C	2x1-1/4	2-3/4	1-1/2	2-7/16	3-7/16	2-1/16	5/16	.61	.64
866-251	866-251C	2x1-1/2	2-15/16	1-1/2	2-7/16	3-7/16	2-3/8	5/16	.65	.70
866-291	866-291C	2-1/2x1-1/2	3-3/16	1-11/16	4-1/16	4	2-3/8	3/8	1.02	1.09
866-333 ¹	866-333C ¹	3x1/2	3-5/16	2-1/16	3	4-5/8	1-3/8	13/16	.88	.92
866-334	866-334C	3x3/4	3-1/16	2-1/16	3	4-5/8	1-3/8	9/32	.85	.89
866-335	866-335C	3x1	3-3/16	2-1/16	3	4-5/8	1-11/16	5/16	.87	.91
866-336 ¹	866-336C ¹	3x1-1/4	4-1/32	2-1/16	4-3/32	4-5/8	3	1-1/32	1.48	1.56
866-337 ¹	866-337C ¹	3x1-1/2	4-1/32	2-1/16	4-3/32	4-5/8	3	29/32	1.41	1.52
866-338	866-338C	3x2	3-5/8	2-1/16	4-3/32	4-5/8	3	3/8	1.24	1.31
866-415 ¹	866-415C ¹	4x1/2	4-3/32	2-5/8	3	5-9/16	2-3/8	31/32	1.31	1.38
866-416 ¹	866-416C ¹	4x3/4	4-3/32	2-5/8	3	5-9/16	2-3/8	27/32	1.29	1.35
866-417	866-417C	4x1	3-13/16	2-5/8	3	5-5/8	1-11/16	7/16	1.24	1.31
866-418 ¹	866-418C ¹	4x1-1/4	4-13/32	2-5/8	4-3/32	5-5/8	2-3/8	29/32	1.70	1.80
866-419	866-419C	4x1-1/2	4-1/8	2-5/8	4-3/32	5-9/16	2-3/8	1/2	1.63	1.72
866-420	866-420C	4x2	4-3/16	2-5/8	4-1/8	5-5/8	3	7/16	1.69	1.79
866-421 ¹	866-421C ¹	4x2-1/2	5	2-5/8	5-7/16	5-23/32	4-9/32	3/4	2.78	2.95
866-422	866-422C	4x3	4-5/8	2-19/32	5-7/16	5-11/16	4-1/4	1/2	2.39	2.57
866-523 ¹	866-523C ¹	6x1/2	5-13/32	3-7/8	3	7-3/4	1-11/16	1-7/32	2.35	2.50
866-524 ¹	866-524C ¹	6x3/4	5-7/16	3-7/8	3	7-3/4	1-11/16	1-1/8	2.33	2.47
866-525	866-525C	6x1	5-1/8	3-7/8	3	7-15/16	1-11/16	11/16	2.29	2.43
866-526 ¹	866-526C ¹	6x1-1/4	5-15/16	3-7/8	4-1/8	7-3/4	3	1-3/8	3.28	3.48
866-527 ¹	866-527C ¹	6x1-1/2	5-15/16	3-7/8	4-1/8	7-3/4	3	1-1/4	3.22	3.43
866-528	866-528C	6x2	5-1/2	3-7/8	4-1/8	7-3/4	3	11/16	3.04	3.23
866-529 ¹	866-529C ¹	6x2-1/2	6-7/16	3-7/8	6	7-15/16	4-1/4	1-1/8	4.73	5.02
866-530	866-530C	6x3	5-15/16	3-7/8	6	7-15/16	4-1/4	25/32	4.35	4.61
866-532	866-532C	6x4	6	3-29/32	6	7-15/16	5-3/16	5/8	5.09	5.49

¹ Outlet sized with bushing

PVC & CPVC SCHEDULE 80 FITTINGS, UNIONS, TANK ADAPTERS, EXPANSION JOINTS & SADDLES

CLAMP-ON SADDLE x SOCKET SINGLE OUTLET

(continued)

Dimensions Applicable to
866S-XXX 866V-XXX 866SV-XXX

2" - 4 235 psi @ 73°F
6" 200 psi @ 73°F
8" - 12" 150 psi @ 73°F

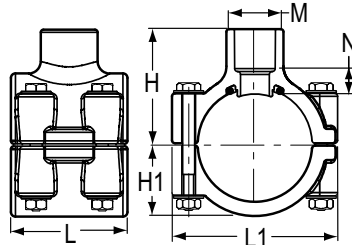

Part Number		Size	H	H1	L	L1	M	N	Approx. Wt. (Lbs.)	
PVC	CPVC								PVC	CPVC
866-573 ¹	866-573C ¹	8x1/2	7-3/4	4-7/8	9-1/2	8-1/2	5-5/16	1-1/2	---	---
866-574 ¹	866-574C ¹	8x3/4	8-3/32	4-7/8	8-1/2	10-1/8	5-1/4	2-3/4	---	---
866-575 ¹	866-575C ¹	8x1	8-3/32	4-7/8	8-1/2	10-1/8	5-1/4	2-5/8	---	---
866-576 ¹	866-576C ¹	8x1-1/4	8-3/32	4-7/8	8-1/2	10-1/8	5-1/4	2-1/2	---	---
866-577 ¹	866-577C ¹	8x1-1/2	8-3/32	4-7/8	8-1/2	10-1/8	5-1/4	2-3/8	---	---
866-578 ¹	866-578C ¹	8x2	7-11/16	4-7/8	8-1/2	10-1/8	5-1/4	1-7/8	---	---
866-579 ¹	866-579C ¹	8x2-1/2	8-5/32	4-7/8	8-15/32	10	5-7/32	2-1/2	5.24	---
866-580 ¹	866-580C ¹	8x3	7-1/16	4-7/8	8-1/2	10-1/8	5-1/4	1-7/16	---	---
866-582	866-582C	8x4	7-5/16	4-7/8	8-1/2	10-1/8	5-1/4	11/16	4.07	4.38
866-585	866-585C	8x6	8-3/32	4-7/8	8-1/2	10-1/8	7-5/8	11/16	9.80	9.30
866-621 ¹	866-621C ¹	10x2	8-7/8	6-1/32	8-1/2	12-5/16	5-1/4	1-15/16	---	---
866-624	866-624C	10x4	8-15/32	6-1/32	8-1/2	12-5/16	5-1/4	13/16	---	---
866-626	866-626C	10x6	9-9/32	6-1/32	8-1/2	12-5/16	7-5/8	13/16	---	---
866-664	866-664C	12x4	9-9/16	7-5/32	8-1/2	14-5/16	5-1/4	7/8	---	---
866-666	866-666C	12x6	10-3/8	7-5/32	8-1/2	14-5/16	7-5/8	7/8	---	---

¹ Outlet sized with bushing

- 1) Clamp On Saddle Standard Hardware: Zinc Bolts w/EPDM O-ring Seal
e.g. Part Number 866-247 = 2x1/2 PVC Clamp On Saddle, Socket, EPDM O-ring, Zinc Bolts.
- 2) Clamp On Saddles w/Stainless Steel (SS) Bolts, Add The Letter "S" Before The Dash.
e.g. Part Number 866S-247 = 2x1/2 PVC Clamp On Saddle, Socket, EPDM O-ring, Stainless Steel Bolts.
- 3) Clamp On Saddles w/Viton® O-ring Seal, Add The Letter "V" Before The Dash.
e.g. Part Number 866V-247 = 2x1/2 PVC Clamp-On Saddle, Socket, Viton® O-ring, Zinc Bolts.
- 4) Clamp-On Saddles w/Stainless Steel Bolts & Viton® O-ring Seal, Add The Letter "SV" Before The Dash.
e.g. Part Number 866SV-247 = 2x1/2 PVC Clamp On Saddle, Socket Viton® O-ring, Stainless Steel Bolts.

Viton® is registered trademark of DuPont Dow Elastomers.

PVC & CPVC SCHEDULE 80 FITTINGS, UNIONS, TANK ADAPTERS, EXPANSION JOINTS & SADDLES

CLAMP-ON SADDLE x SR FIPT SINGLE OUTLET

Dimensions Applicable to
867S-XXX 867V-XXX 867SV-XXX

2" - 4 235 psi @ 73°F
6" 200 psi @ 73°F
8" - 12" 150 psi @ 73°F

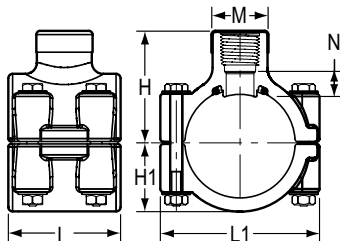

Part Number		Size	H	H1	L	L1	M	N	Approx. Wt. (Lbs.)	
PVC	CPVC								PVC	CPVC
867-247SR	867-247CSR	2x1/2	2-3/8	1-1/2	2-7/16	3-7/16	1-3/16	5/16	.56	.59
867-248SR	867-248CSR	2x3/4	2-1/2	1-1/2	2-7/16	3-7/16	1-3/8	5/8	.57	.60
867-249SR	867-249CSR	2x1	2-5/8	1-1/2	2-7/16	3-7/16	1-11/16	9/16	.40	.62
867-250SR	867-250CSR	2x1-1/4	2-3/4	1-1/2	2-7/16	3-7/16	2-1/16	11/16	.61	.64
867-251SR	867-251CSR	2x1-1/2	2-15/16	1-1/2	2-7/16	3-7/16	2-3/8	3/4	.65	.70
867-291SR	867-291CSR	2-1/2x1-1/2	3-3/16	1-11/16	4-1/16	4	2-3/8	13/16	1.02	1.09
867-333SR ¹	867-333CSR ¹	3x1/2	3-5/16	2-1/16	3	4-5/8	1-3/8	15/16	.89	.93
867-334SR	867-334CSR	3x3/4	3-1/16	2-1/16	3	4-5/8	1-3/8	9/16	.87	.91
867-335SR	867-335CSR	3x1	3-3/16	2-1/16	3	4-5/8	1-11/16	9/16	.89	.93
867-336SR ¹	867-336CSR ¹	3x1-1/4	4-1/32	2-1/16	4-3/32	4-5/8	3	1-5/16	1.51	1.61
867-337SR ¹	867-337CSR ¹	3x1-1/2	4-1/32	2-1/16	4-3/32	4-5/8	3	2-11/16	1.47	1.56
867-338SR	867-338CSR	3x2	3-5/8	2-1/16	4-3/32	4-5/8	3	7/8	1.36	1.40
867-415SR ¹	867-415CSR ¹	4x1/2	4-3/32	2-5/8	3	5-9/16	2-3/8	1-1/8	1.32	1.39
867-416SR ¹	867-416CSR ¹	4X3/4	4-3/32	2-5/8	3	5-9/16	2-3/8	1-1/8	1.31	1.38
867-417SR	867-417CSR	4x1	3-13/16	2-5/8	3	5-5/8	1-11/16	11/16	1.26	1.33
867-418SR ¹	867-418CSR ¹	4x1-1/4	4-13/32	2-5/8	4-3/32	5-5/8	2-3/8	1-7/32	1.75	1.85
867-419SR ¹	867-419CSR ¹	4x1-1/2	4-1/8	2-5/8	4-3/32	5-9/16	2-3/8	15/16	1.68	1.78
867-420SR	867-420CSR	4x2	4-3/16	2-5/8	4-1/8	5-5/8	3	15/16	1.78	1.87
867-421SR ¹	867-421CSR ¹	4x2-1/2	5	2-5/8	5-7/16	5-23/32	4-9/32	1-7/32	2.91	3.13
867-422SR	867-422CSR	4x3	4-5/8	2-19/32	5-7/16	5-11/16	4-1/4	31/32	2.53	2.69
867-523SR ¹	867-523CSR ¹	6x1/2	5-13/32	3-7/8	3	7-3/4	1-11/16	1-3/8	2.37	2.50
867-524SR ¹	867-524CSR ¹	6x3/4	5-7/16	3-7/8	3	7-3/4	1-11/16	1-3/8	2.35	2.50
867-525SR	867-525CSR	6x1	5-1/8	3-7/8	3	7-15/16	1-11/16	15/16	2.31	2.45
867-526SR ¹	867-526SR ¹	6x1-1/4	5-15/16	3-7/8	4-1/8	7-3/4	3	1-11/16	3.31	3.52
867-527SR ¹	867-527CSR ¹	6x1-1/2	5-15/16	3-7/8	4-1/8	7-3/4	3	1-3/4	3.27	3.48
867-528SR	867-528CSR	6x2	5-1/2	3-7/8	4-1/8	7-3/4	3	1-7/32	3.13	3.32
867-529SR ¹	867-529CSR ¹	6x2-1/2	6-7/16	3-7/8	6	7-15/16	4-1/4	1-9/16	4.87	5.17
867-530SR	867-530CSR	6x3	5-15/16	3-7/8	6	7-15/16	4-1/4	1-1/4	4.46	4.78
867-532SR	867-532CSR	6x4	6	3-29/32	6	7-15/16	5-3/16	1-3/8	5.44	5.78

¹ Outlet sized with bushing

PVC & CPVC SCHEDULE 80 FITTINGS, UNIONS, TANK ADAPTERS, EXPANSION JOINTS & SADDLES

CLAMP-ON SADDLE x SR FIPT SINGLE OUTLET

(continued)

Dimensions Applicable to
867S-XXX 867V-XXX 867SV-XXX

2" - 4 235 psi @ 73°F
6" 200 psi @ 73°F
8" - 12" 150 psi @ 73°F

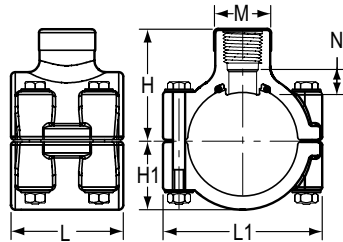

Part Number		Size	H	H1	L	L1	M	N	Approx. Wt. (Lbs.)	
PVC	CPVC								PVC	CPVC
867-573SR	867-573SR	8x1/2	8-3/32	4-7/8	8-1/2	10-1/8	5-1/4	3	---	---
867-574SR ¹	867-574SR ¹	8x3/4	8-3/32	4-7/8	8-1/2	10-1/8	5-1/4	3	---	---
867-575SR	867-575SR	8x1	8-3/32	4-7/8	8-1/2	10-1/8	5-1/4	2-13/16	---	---
867-576SR ¹	867-576SR ¹	8x1-1/4	9-5/16	4-15/16	8-9/16	9-29/32	5-7/32	1-19/32	9.68	---
867-577SR ¹	867-577SR ¹	8x1-1/2	8-3/32	4-7/8	8-1/2	10-1/8	5-1/4	2-3/4	---	---
867-578SR ¹	867-578SR ¹	8x2	7-11/16	4-7/8	8-1/2	10-1/8	5-1/4	2-3/8	---	---
867-579SR ¹	867-579SR ¹	8x2-1/2	8-1/8	4-7/8	8-1/2	10-1/8	5-1/4	2-1/2	---	---
867-580SR ¹	867-580SR ¹	8x3	7-1/16	4-7/8	8-1/2	10-1/8	5-1/4	1-15/16	---	---
867-582SR	867-582SR	8x4	7-5/16	4-7/8	8-1/2	10-1/8	5-1/4	1-1/2	7.74	8.09
867-585SR	867-585SR	8x6	8-3/32	4-7/8	8-1/2	10-1/8	7-5/8	2-3/32	8-61	9.08
867-624SR	867-624SR	10x4	8-15/32	6-1/32	8-1/2	12-5/16	5-1/4	2-3/16	---	---
867-626SR	867-626SR	10x6	9-9/32	6-1/32	8-1/2	12-5/16	7-5/8	3-3/16	---	---
867-664SR	867-664SR	12x4	9-9/16	7-5/32	8-1/2	14-5/16	5-1/4	1-5/8	---	---
867-666SR	867-666SR	12x6	10-3/8	7-5/32	8-1/2	14-5/16	7-5/8	2-1/4	---	---

¹ Outlet sized with bushing

- 1) Clamp On Saddle Standard Hardware: Zinc Bolts w/EPDM O-ring Seal
e.g. Part Number 867-247SR = 2x1/2 PVC Clamp On Saddle, SR Thread, EPDM O-ring, Zinc Bolts.
 - 2) Clamp On Saddles w/Stainless Steel (SS) Bolts, Add The Letter "S" Before The Dash.
e.g. Part Number 867S-247SR = 2x1/2 PVC Clamp On Saddle, SR Thread, EPDM O-ring, Stainless Steel Bolts.
 - 3) Clamp On Saddles w/Viton® O-ring Seal, Add The Letter "V" Before The Dash.
e.g. Part Number 867V-247SR = 2x1/2 PVC Clamp-On Saddle, SR Thread, Viton® O-ring, Zinc Bolts.
 - 4) Clamp-On Saddles w/Stainless Steel Bolts & Viton® O-ring Seal, Add The Letter "SV" Before The Dash.
e.g. Part Number 867SV-247SR = 2x1/2 PVC Clamp On Saddle, SR Thread Viton® O-ring, Stainless Steel Bolts.
- Viton® is a registered trademark of DuPont Dow Elastomers.

PVC & CPVC SCHEDULE 80 FITTINGS, UNIONS, TANK ADAPTERS, EXPANSION JOINTS & SADDLES

CLAMP-ON SADDLE x SOCKET

DOUBLE OUTLET

Dimensions Applicable to
868S-XXX 868V-XXX 868SV-XXX

2" - 4 235 psi @ 73°F
6" 200 psi @ 73°F
8" - 12" 150 psi @ 73°F

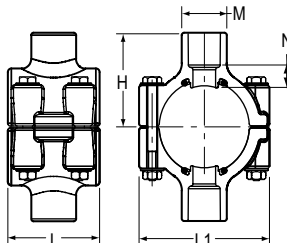

Part Number		Size	H	L	L1	M	N	Approx. Wt. (Lbs.)	
PVC	CPVC							PVC	CPVC
868-247	868-247C	2x1/2	2-3/8	2-7/16	3-7/16	1-3/16	5/16	.56	.59
868-248	868-248C	2x3/4	2-1/2	2-7/16	3-7/16	1-3/8	5/16	.57	.60
868-249	868-249C	2x1	2-5/8	2-7/16	3-7/16	1-11/16	5/16	.40	.62
838-250	838-250C	2x1-1/4	2-3/4	2-7/16	3-7/16	2-1/16	5/16	.61	.64
868-251	868-251C	2x1-1/2	2-15/16	2-7/16	3-7/16	2-3/8	5/16	.65	.70
868-291	868-291C	2-1/2x1-1/2	3-3/16	4-1/16	4	2-3/8	3/8	1.02	1.09
868-333 ¹	868-333C ¹	3x1/2	3-5/16	3	4-5/8	1-3/8	13/16	.93	.97
868-334	868-334C	3x3/4	3-1/16	3	4-5/8	1-3/8	9/32	.89	.92
868-335	868-335C	3x1	3-3/16	3	4-5/8	1-11/16	5/16	.91	.96
868-336 ¹	868-336C ¹	3x1-1/4	4-1/32	4-3/32	4-5/8	3	1-1/32	1.94	2.06
868-337 ¹	868-337C ¹	3x1-1/2	4-1/32	4-3/32	4-5/8	3	29/32	1.82	1.97
868-338	868-338C	3x2	3-5/8	4-3/32	4-5/8	3	3/8	1.47	1.57
868-415 ¹	868-415C ¹	4x1/2	4-3/32	3	5-9/16	2-3/8	31/32	1.43	1.51
868-416 ¹	868-416C ¹	4X3/4	4-3/32	3	5-9/16	2-3/8	27/32	1.39	1.46
868-417	868-417C	4x1	3-13/16	3	5-5/8	1-11/16	7/16	1.30	1.37
868-418 ¹	868-418C ¹	4x1-1/4	4-13/32	4-3/32	5-5/8	2-3/8	29/32	1.92	2.04
868-419	868-419C	4x1-1/2	4-1/8	4-3/32	5-9/16	2-3/8	1/2	1.77	1.87
868-420	868-420C	4x2	4-3/16	4-1/8	5-5/8	3	7/16	1.90	2.01
868-421 ¹	868-421C ¹	4x2-1/2	5	5-7/16	5-23/32	4-9/32	3/4	3.69	3.98
868-422	868-422C	4x3	4-5/8	5-7/16	5-11/16	4-1/4	1/2	2.92	3.16
868-523 ¹	868-523C ¹	6x1/2	5-13/32	3	7-3/4	1-11/16	1-7/32	2.48	2.63
868-524 ¹	868-524C ¹	6x3/4	5-7/16	3	7-3/4	1-11/16	1-1/8	2.44	2.58
868-525	868-525C	6x1	5-1/8	3	7-15/16	1-11/16	11/16	2.35	2.49
868-526 ¹	868-526C ¹	6x1-1/4	5-15/16	4-1/8	7-3/4	3	1-3/8	3.72	3.93
868-527 ¹	868-527C ¹	6x1-1/2	5-15/16	4-1/8	7-3/4	3	1-1/4	3.60	3.84
868-528	868-528C	6x2	5-1/2	4-1/8	7-3/4	3	11/16	3.25	3.44
868-529 ¹	868-529C ¹	6x2-1/2	6-7/16	6	7-15/16	4-1/4	1-1/8	5.58	5.93
868-530	868-530C	6x3	5-15/16	6	7-15/16	4-1/4	25/32	4.81	5.11
868-532	868-532C	6x4	6	6	7-15/16	5-3/16	5/8	5.56	6.10
868-573 ¹	868-573C ¹	8x1/2	8-3/32	8-1/2	10-1/8	5-1/4	2-3/16	11.50	12.06

¹ Outlet sized with bushing

PVC & CPVC SCHEDULE 80 FITTINGS, UNIONS, TANK ADAPTERS, EXPANSION JOINTS & SADDLES

CLAMP-ON SADDLE x SOCKET DOUBLE OUTLET (continued)

Dimensions Applicable to
868S-XXX 868V-XXX 868SV-XXX

2" - 4 235 psi @ 73°F
6" 200 psi @ 73°F
8" - 12" 150 psi @ 73°F

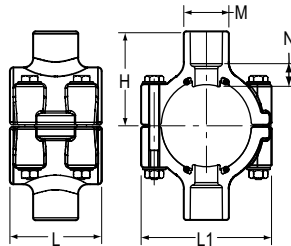

Part Number		Size	H	L	L1	M	N	Approx. Wt. (Lbs.)	
PVC	CPVC							PVC	CPVC
868-574 ¹	868-574C ¹	8x3/4	8-3/32	8-1/2	10-1/8	5-1/4	2-3/4	11.45	12.01
868-575 ¹	868-575C ¹	8x1	8-3/32	8-1/2	10-1/8	5-1/4	2-5/8	11.52	12.02
868-576 ¹	868-576C ¹	8x1-1/4	8-3/32	8-1/2	10-1/8	5-1/4	2-1/2	11.48	11.88
868-577 ¹	868-577C ¹	8x1-1/2	8-3/32	8-1/2	10-1/8	5-1/4	2-3/8	11.30	11.78
868-578 ¹	868-578C ¹	8x2	7-11/16	8-1/2	10-1/8	5-1/4	1-7/8	11.00	11.47
868-579 ¹	868-579C ¹	8x2-1/2	8-1/8	8-1/2	10-1/8	5-1/4	1-11/16	8.90	9.21
868-580 ¹	868-580C ¹	8x3	7-1/16	8-1/2	10-1/8	5-1/4	1-7/16	10.53	10.92
868-582	868-582C	8x4	7-5/16	8-1/2	10-1/8	5-1/4	11/16	8.00	8.62
868-585	868-585C	8x6	8-3/32	8-1/2	10-1/8	7-5/8	11/16	10.32	10.81
868-624	868-624C	10x4	8-15/32	8-1/2	12-5/16	5-1/4	13/16	15.37	12.99
868-626	868-626C	10x6	9-9/32	8-1/2	12-5/16	7-5/8	13/16	14.51	15.15
868-664	868-664C	12x4	9-9/16	8-1/2	14-5/16	5-1/4	7/8	15.75	17.06
868-666	868-666C	12x6	10-3/8	8-1/2	14-5/16	7-5/8	7/8	17.58	18.64

¹ Outlet sized with bushing

- 1) Clamp On Saddle Standard Hardware: Zinc Bolts w/EPDM O-ring Seal
e.g. Part Number 868-247 = 2x1/2 PVC Clamp On Saddle, Socket, EPDM O-ring, Zinc Bolts.
- 2) Clamp On Saddles w/Stainless Steel (SS) Bolts, Add The Letter "S" Before The Dash.
e.g. Part Number 868S-247 = 2x1/2 PVC Clamp On Saddle, Socket, EPDM O-ring, Stainless Steel Bolts.
- 3) Clamp On Saddles w/Viton® O-ring Seal, Add The Letter "V" Before The Dash.
e.g. Part Number 868V-247 = 2x1/2 PVC Clamp-On Saddle, Socket, Viton® O-ring, Zinc Bolts.
- 4) Clamp-On Saddles w/Stainless Steel Bolts & Viton® O-ring Seal, Add The Letter "SV" Before The Dash.
e.g. Part Number 868SV-247 = 2x1/2 PVC Clamp On Saddle, Socket Viton® O-ring, Stainless Steel Bolts.

Viton® is a registered trademark of DuPont Dow Elastomers.

PVC & CPVC SCHEDULE 80 FITTINGS, UNIONS, TANK ADAPTERS, EXPANSION JOINTS & SADDLES

CLAMP-ON SADDLE x SR FIPT

DOUBLE OUTLET

Dimensions Applicable to
869S-XXX 869V-XXX 869SV-XXX

2" - 4 235 psi @ 73°F
6" 200 psi @ 73°F
8" - 12" 150 psi @ 73°F

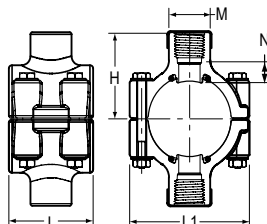

Part Number		Size	H	L	L1	M	N	Approx. Wt. (Lbs.)	
PVC	CPVC							PVC	CPVC
869-247SR	869-247CSR	2x1/2	2-3/8	2-7/16	3-7/16	1-3/16	5/16	.56	.59
869-248SR	869-248CSR	2x3/4	2-1/2	2-7/16	3-7/16	1-3/8	5/8	.57	.60
869-249SR	869-249CSR	2x1	2-5/8	2-7/16	3-7/16	1-11/16	9/16	.40	.62
869-250SR	869-250CSR	2x1-1/4	2-3/4	2-7/16	3-7/16	2-1/16	11/16	.61	.64
869-251SR	869-251CSR	2x1-1/2	2-15/16	2-7/16	3-7/16	2-3/8	3/4	.65	.70
869-291SR	869-291CSR	2-1/2x1-1/2	3-3/16	4-1/16	4	2-3/8	13/16	1.02	1.09
869-333SR ¹	869-333CSR ¹	3x1/2	3-5/16	3	4-5/8	1-3/8	15/16	.96	1.00
869-334SR	869-334CSR	3x3/4	3-1/16	3	4-5/8	1-3/8	9/16	.93	.96
869-335SR	869-335CSR	3x1	3-3/16	3	4-5/8	1-11/16	9/16	.95	1.00
869-336SR ¹	869-336CSR ¹	3x1-1/4	4-1/32	4-3/32	4-5/8	3	1-5/16	2.01	2.15
869-337SR ¹	869-337CSR ¹	3x1-1/2	4-1/32	4-3/32	4-5/8	3	2-11/16	1.93	2.06
869-338SR	869-338CSR	3x2	3-5/8	4-3/32	4-5/8	3	7/8	1.71	1.74
869-415SR ¹	869-415CSR ¹	4x1/2	4-3/32	3	5-9/16	2-3/8	1-1/8	1.46	1.53
869-416SR ¹	869-416CSR ¹	4x3/4	4-3/32	3	5-9/16	2-3/8	1-1/8	1.43	1.52
869-417SR	869-417CSR	4x1	3-13/16	3	5-5/8	1-11/16	11/16	1.34	1.41
869-418SR ¹	869-418CSR ¹	4x1-1/4	4-13/32	4-3/32	5-5/8	2-3/8	1-7/32	2.02	2.13
869-419SR	869-419CSR	4x1-1/2	4-1/8	4-3/32	5-9/16	2-3/8	15/16	1.87	1.99
869-420SR	869-420CSR	4x2	4-3/16	4-1/8	5-5/8	3	15/16	2.08	2.18
869-421SR ¹	869-421CSR ¹	4x2-1/2	5	5-7/16	5-23/32	4-9/32	1-7/32	3.96	4.29
869-422SR	869-422CSR	4x3	4-5/8	5-7/16	5-11/16	4-1/4	31/32	3.19	3.39
869-523SR ¹	869-523CSR ¹	6x1/2	5-13/32	3	7-3/4	1-11/16	1-3/8	2.51	2.64
869-524SR ¹	869-524CSR ¹	6x3/4	5-7/16	3	7-3/4	1-11/16	1-3/8	2.48	2.63
869-525SR	869-525CSR	6x1	5-1/8	3	7-15/16	1-11/16	15/16	2.39	2.53
869-526SR ¹	869-526CSR ¹	6x1-1/4	5-15/16	4-1/8	7-3/4	3	1-11/16	3.79	4.03
869-527SR ¹	869-527CSR ¹	6x1-1/2	5-15/16	4-1/8	7-3/4	3	1-3/4	3.70	3.93
869-528SR	869-528CSR	6x2	5-1/2	4-1/8	7-3/4	3	1-7/32	3.43	3.62
869-529SR ¹	869-529CSR ¹	6x2-1/2	6-7/16	6	7-15/16	4-1/4	1-9/16	5.85	6.23
869-530SR	869-530CSR	6x3	5-15/16	6	7-15/16	4-1/4	1-1/4	5.04	5.45
869-532SR	869-532CSR	6x4	6	6	7-15/16	5-3/16	1-3/8	6.26	6.67
869-573SR ¹	869-573CSR ¹	8x1/2	8-3/32	8-1/2	10-1/8	5-1/4	3	11.52	12.02

¹ Outlet sized with bushing

PVC & CPVC SCHEDULE 80 FITTINGS, UNIONS, TANK ADAPTERS, EXPANSION JOINTS & SADDLES

CLAMP-ON SADDLE x SR FIPT (continued) DOUBLE OUTLET

Dimensions Applicable to
869S-XXX 869V-XXX 869SV-XXX

2" - 4 235 psi @ 73°F
6" 200 psi @ 73°F
8" - 12" 150 psi @ 73°F

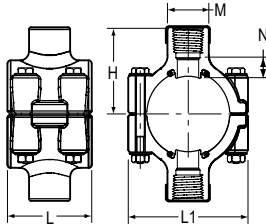

Part Number		Size	H	L	L1	M	N	Approx. Wt. (Lbs.)	
PVC	CPVC							PVC	CPVC
869-574SR ¹	869-574CSR ¹	8x3/4	8-3/32	8-1/2	10-1/8	5-1/4	3	---	---
869-575SR ¹	869-575CSR ¹	8x1	8-3/32	8-1/2	10-1/8	5-1/4	2-13/16	---	---
869-576SR ¹	869-576CSR ¹	8x1-1/4	8-3/32	8-1/2	10-1/8	5-1/4	2-3/4	---	---
869-577SR ¹	869-577CSR ¹	8x1-1/2	8-3/32	8-1/2	10-1/8	5-1/4	2-3/4	---	---
869-578SR ¹	869-578CSR ¹	8x2	7-11/16	8-1/2	10-1/8	5-1/4	2-3/8	---	---
869-579SR ¹	869-579CSR ¹	8x2-1/2	8-1/8	8-1/2	10-1/8	5-1/4	2-1/2	---	---
869-580SR ¹	869-580CSR ¹	8x3	7-1/16	8-1/2	10-1/8	5-1/4	1-15/16	---	---
869-582SR	869-582CSR	8x4	7-5/16	8-1/2	10-1/8	5-1/4	1-1/2	8.59	9.29
869-585SR	869-585CSR	8x6	8-3/32	8-1/2	10-1/8	7-5/8	2-3/32	10.32	10.81
869-624SR	869-624CSR	10x4	8-15/32	8-1/2	12-5/16	5-1/4	2-3/16	---	---
869-626SR	869-626CSR	10x6	9-9/32	8-1/2	12-5/16	7-5/8	3-3/16	---	---
869-664SR	869-664CSR	12x4	9-9/16	8-1/2	14-5/16	5-1/4	1-5/8	---	---
869-666SR	869-666SR	12x6	10-3/8	8-1/2	14-5/16	7-5/8	2-1/4	---	---

¹ Outlet sized with bushing

- 1) Clamp On Saddle Standard Hardware: Zinc Bolts w/EPDM O-ring Seal
e.g. Part Number 869-247SR = 2x1/2 PVC Clamp On Saddle, SR Thread , EPDM O-ring, Zinc Bolts.
- 2) Clamp On Saddles w/Stainless Steel (SS) Bolts, Add The Letter "S" Before The Dash.
e.g. Part Number 869S-247SR = 2x1/2 PVC Clamp On Saddle, SR Thread, EPDM O-ring, Stainless Steel Bolts.
- 3) Clamp On Saddles w/Viton® O-ring Seal, Add The Letter "V" Before The Dash.
e.g. Part Number 869V-247 = 2x1/2 PVC Clamp-On Saddle, SR Thread, Viton® O-ring, Zinc Bolts.
- 4) Clamp-On Saddles w/Stainless Steel Bolts & Viton® O-ring Seal, Add The Letter "SV" Before The Dash.
e.g. Part Number 869SV-247SR = 2x1/2 PVC Clamp On Saddle, SR Thread Viton® O-ring, Stainless Steel Bolts.

Viton® is a registered trademark of DuPont Dow Elastomers.

PVC & CPVC SCHEDULE 80 FITTINGS, UNIONS, TANK ADAPTERS, EXPANSION JOINTS & SADDLES

WYE

Soc x Soc x Soc

1/2" - 2-1/2" 235 psi @ 73°F
 3" - 6" 150 psi @ 73°F
 8" & Up 100 psi @ 73°F

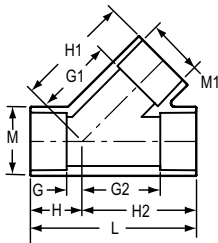

Part Number		Size	G	G1	G2	H	H1	H2	L	M	M1	Approx. Wt. (Lbs.)	
												PVC	CPVC
875-005	875-005C	1/2	1/4	1-5/32	1-5/32	1-1/8	2-1/16	2-1/32	3-3/16	1-5/32	1-5/32	.12	.13
875-007	875-007C	3/4	9/32	13/32	13/32	1-9/32	2-7/6	2-13/32	3-11/16	1-3/8	1-3/8	.18	.19
875-010	875-010C	1	5/16	1-3/4	1-3/4	1-7/16	2-29/32	2-7/8	4-11/32	1-11/16	1-11/16	.31	.33
875-012	875-012C	1-1/4	13/32	2-5/32	2-5/32	1-21/32	3-13/32	3-13/32	5-3/32	2-1/16	2-1/16	.50	.53
875-015	875-015C	1-1/2	11/16	2-13/32	2-3/8	2-1/16	3-3/4	3-3/4	5-13/16	2-11/32	2-5/16	.69	.74
875-020	875-020C	2	21/32	3-7/32	3-7/32	2-5/32	4-23/32	4-23/32	6-7/8	2-7/8	2-7/8	1.20	1.26
875-025	875-025C	2-1/2	1	4-7/8	4-7/16	3	6-7/8	6-7/8	9-7/16	4-1/8	4-1/8	3.74	3.70
875-030	875-030C	3	11/16	4-21/32	4-1/4	2-9/16	6-17/32	6-1/8	8-11/16	4-1/8	4-1/8	2.59	2.67
875-040	875-040C	4	25/32	6	5-13/32	3	8-1/4	7-11/16	10-11/16	5-1/4	5-1/4	4.66	4.70
875-060	875-060C	6	1-13/32	8-5/8	7-21/32	4-13/32	11-5/8	10-31/32	15-3/8	7-9/16	7-9/16	12.05	12.67
875-080	875-080C	8	2-1/16	11-1/16	11-1/4	6-1/16	15-1/4	15-1/4	21-1/4	9-23/32	9-23/32	25.24	26.18
875-080F	875-080CF	8	5-1/16	13-11/16	13-11/16	9-5/16	17-15/16	17-15/16	27-1/4	9-5/8	9-5/8	39.76	44.67
875-100F	875-100CF	10	5-7/8	17-7/8	17-7/8	11-1/8	23-1/8	23-1/8	37-11/16	12	12	65.51	75.04
875-120F	875-120CF	12	7-1/8	19-7/8	19-7/8	13-3/8	26-1/8	26-1/8	39-1/2	14-1/8	14-1/8	109.85	123.20
875-140F	875-140CF	14	9-5/8	23-3/8	23-3/8	16-5/8	30-3/8	30-3/8	47	15-1/2	15-1/2	135.75	149.48
875-160F	875-160CF	16	9-3/8	25-3/8	25-3/8	17-3/8	33-3/8	33-3/8	50-3/4	17-3/4	17-3/4	183.59	211.73
875-180F	875-180CF	18	10	28	28	19	37	37	56	19-7/8	19-7/8	255.49	292.04
875-200F	---	20	11-5/8	31-5/8	31-5/8	21-5/8	41-5/8	41-5/8	63-1/4	22-1/8	22-1/8	399.60	---
875-240F	---	24	14-1/4	38-1/4	38-1/4	26-1/4	50-1/4	50-1/4	76-1/2	26-1/2	26-1/2	617.50	---

PVC & CPVC SCHEDULE 80 FITTINGS, UNIONS, TANK ADAPTERS, EXPANSION JOINTS & SADDLES

REDUCING WYE

Soc x Soc x Soc

1/2" - 2-1/2" 235 psi @ 73°F
 3" - 6" 150 psi @ 73°F
 8" & Up 100 psi @ 73°F

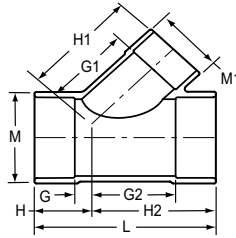

Part Number		Size	G	G1	G2	H	H1	H2	L	M	M1	Approx. Wt. (Lbs.)	
PVC	CPVC											PVC	CPVC
875-167 ¹	875-167C ¹	1-1/4x1-1/4x3/4	3/8	2-3/4	2-1/4	1-5/8	3-3/4	3-1/2	5-1/8	2-1/16	2-1/16	.61	.65
875-168 ¹	875-168C ¹	1-1/4x1-1/4x1	3/8	2-5/8	2-1/4	1-5/8	3-3/4	3-1/2	5-1/8	2-1/16	2-1/16	.56	.62
875-210 ¹	875-210C ¹	1-1/2x1-1/2x3/4	1/2	3-1/2	2-9/16	1-7/8	4-1/2	3-15/16	5-13/16	2-11/32	2-11/32	.88	.94
875-211 ¹	875-211C ¹	1-1/2x1-1/2x1	1/2	3	2-9/16	1-7/8	4-5/32	3-15/16	5-13/16	2-11/32	2-11/32	.83	.89
875-212 ¹	875-212C ¹	1-1/2x1-1/2x1-1/4	1/2	3-1/4	2-9/16	1-7/8	4-1/2	3-15/16	5-13/16	2-11/32	2-11/32	.74	.82
875-250 ¹	875-250C ¹	2x2x1-1/4	5/8	3-5/16	3-3/8	2-5/32	5	4-3/4	6-7/8	2-7/8	2-7/8	1.46	1.52
875-291 ¹	---	2-1/2x2-1/2x1-1/2	1	6-1/4	4-9/16	3-1/16	7-5/8	6-5/8	9-11/16	4-3/16	4-3/16	4.34	---
875-292 ¹	---	2-1/2x2-1/2x2	1/2	3-3/4	4-3/4	2-1/2	6-7/8	6-1/2	9-3/8	4-1/4	4-1/4	3.97	---
875-335 ¹	875-335C ¹	3x3x1	7/8	5-5/8	4-1/8	2-3/4	7	6	8-3/4	4-3/16	4-3/16	3.35	3.40
875-336 ¹	875-336C ¹	3x3x1-1/4	7/8	5-3/4	4-1/8	2-3/4	7	6	8-3/4	4-3/16	4-3/16	3.21	3.34
875-337 ¹	875-337C ¹	3x3x1-1/2	2-5/8	5-1/2	4-1/4	2-5/8	6-7/8	6-1/8	8-3/4	4-3/16	4-3/16	3.14	3.21
875-338 ¹	875-338C ¹	3x3x2	1/2	3-3/4	3-3/4	2-1/2	6-1/2	5-3/4	8-3/4	4-1/4	4-1/4	3.20	3.21
875-339 ¹	875-339C ¹	3x3x2-1/2	7/8	4-1/8	4-21/32	2-3/4	6-3/4	6	8-3/4	4-3/16	4-3/16	2.97	3.11
875-419 ¹	---	4x4x1-1/2	1	6-5/8	5-1/4	3-1/4	8-13/16	7-1/2	10-3/4	5-1/4	5-3/16	6.04	---
875-420F	875-420CF	4x4x2	1/2	7-5/8	5-3/4	2-3/4	9-1/8	8	10-3/4	5-1/4	2-3/4	5.67	6.11
875-421F	---	4x4x2-1/2	2-5/8	5-1/2	7-1/8	4-7/8	7-1/2	9-3/8	14-1/4	5-1/4	3-1/4	5.37	---
875-422 ¹	875-422C ¹	4x4x3	1	7-3/8	5-1/4	3-1/4	9-1/4	7-1/2	10-3/4	5-1/4	5-3/16	5.41	5.81
875-528 ¹	875-528C ¹	6x6x2	1/16	8-23/32	6-5/8	3-1/16	10-7/32	9-5/8	12-11/16	7-9/16	7-9/16	9.71	10.10
875-528F	875-528CF	6x6x2	1-7/8	8-5/8	8-5/8	5-1/8	10-3/8	11-7/8	17	7-1/2	2-13/16	9.36	10.07
875-530 ¹	875-530C ¹	6x6x3	-1/16	8-3/8	6-11/16	3	10-1/4	9-11/16	12-5/8	7-9/16	5-3/8	9.60	9.82
875-530F	875-530CF	6x6x3	2-3/4	9-1/2	9-3/4	6	11-3/4	13	19	7-1/2	4-1/8	13.22	12.14
875-532	875-532C	6x6x4	1/16	7-9/16	6-5/8	3-1/16	9-13/16	9-5/8	12-11/16	7-9/16	7-9/16	9.14	8.85
875-578 ¹	875-578C ¹	8x8x2	2	14-15/16	11-1/4	6	16-9/16	16-7/16	21-1/4	9-11/16	9-11/16	34.05	35.44
875-578F	875-578CF	8x8x2	15/16	10-1/16	9-9/16	5-3/16	11-13/16	13-13/16	19	9-5/8	2-3/4	17.93	16.47
875-580F	875-580CF	8x8x3	2-1/4	10-1/4	10-1/4	6-1/2	12-1/2	14-1/2	21	9-5/8	4-1/8	21.92	18.87
875-582 ¹	875-582C ¹	8x8x4	2	14-3/16	11-1/4	6	16-7/16	15-1/4	21-1/4	9-11/16	9-11/16	32.83	35.13
875-582F	875-582CF	8x8x4	3	12-1/2	11-1/2	7-1/4	14-3/4	15-3/4	23	9-5/8	5-3/16	18.50	27.78
875-585 ¹	875-585C ¹	8x8x6	2	12-15/16	11-1/4	6	15-15/16	15-1/4	21-1/4	9-11/16	9-11/16	30.74	32.29
875-585F	875-585CF	8x8x6	4-3/4	12-15/16	13-3/4	9	16-3/16	18	27	9-5/8	7-1/2	32.97	34.75
875-621 ¹	---	10x10x2	3-3/4	6	14-1/2	9	17-1/2	19-3/4	28-3/4	11	7-1/2	30.84	---

¹ Outlet sized with bushing

PVC & CPVC SCHEDULE 80 FITTINGS, UNIONS, TANK ADAPTERS, EXPANSION JOINTS & SADDLES

REDUCING WYE (continued)

Soc x Soc x Soc

1/2" - 2-1/2" 235 psi @ 73°F
 3" - 6" 150 psi @ 73°F
 8" & Up 100 psi @ 73°F

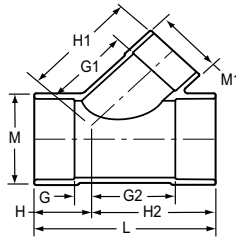

Part Number		Size	G	G1	G2	H	H1	H2	L	M	M1	Approx. Wt. (Lbs.)	
PVC	CPVC											PVC	CPVC
875-621F	875-621CF	10x10x2	-3/8	11-1/8	10-3/4	4-7/8	12-7/8	16	21	12	2-3/4	41.46	26.48
875-622F	---	10x10x2-1/2	3/8	12-15/16	11-1/8	5-5/8	14-15/16	16-3/8	22	12	3-1/4	29.34	---
875-623 ¹	---	10x10x3	7/8	12-7/8	11-5/8	6-1/8	15-1/4	16-7/8	23	12	4-1/8	30.70	---
875-623F	875-623CF	10x10x3	7/8	12-11/16	11-5/8	6-1/8	14-15/16	16-7/8	23	12	4-1/8	36.34	29.62
875-624 ¹	---	10x10x4	1-7/8	10-5/8	12-5/8	7-1/8	12-1/4	17-7/8	25	12	5-3/8	30.56	---
875-624F	875-624CF	10x10x4	1-3/4	14-1/2	12-1/2	7	16-3/4	17-3/4	24-3/4	12	5-3/8	39.93	39.21
875-626	875-626C	10x10x6	-9/32	12-27/32	11-1/32	4-23/32	15-7/8	16-1/32	20-3/4	12-1/32	7-19/32	28.12	31.56
875-626F	875-626CF	10x10x6	3-3/4	14-1/4	14-1/2	9	17-1/2	19-3/4	28-3/4	11-15/16	7-1/2	42.69	46.59
875-628	875-628C	10x10x8	1-7/32	12-3/4	12-1/4	6-7/32	16-25/32	17-9/32	23-1/2	12-1/32	9-23/32	34.14	38.99
875-628F	875-628CF	10x10x8	5-1/4	16-1/4	16	10-1/2	20-1/2	21-1/4	31-3/4	12	9-3/4	55.99	56.37
875-661F	875-661CF	12x12x2	1-1/4	12-3/4	11-1/2	5	14-1/2	17-3/4	22-3/4	14-1/4	2-13/16	37.58	40.76
875-663F	875-663CF	12x12x3	1/4	13-11/16	12-1/2	6	15-15/16	18-3/4	24-3/4	14-1/8	4-1/8	43.39	44.74
875-664F	875-664CF	12x12x4	13/16	15-1/8	13-7/16	7-1/16	17-3/8	19-11/16	26-3/4	14-1/4	5-3/8	48.41	49.06
875-666F	875-666CF	12x12x6	3-1/4	15-1/4	14-3/4	9-1/2	18-1/2	21	30-1/2	14-1/4	7-1/2	64.52	58.24
875-668F	875-668CF	12x12x8	4-1/4	17-5/8	17	10-1/2	21-7/8	23-1/4	33-3/4	14-1/8	9-5/8	71.04	68.98
875-670F	875-670CF	12x12x10	5-3/4	19-3/16	18-1/2	12	24-7/16	24-3/4	36-3/4	14-1/4	12	80.79	81.76
875-694F	---	14x14x4	1-1/4	15-7/8	15-1/4	8-1/4	18-1/8	22-1/4	30-1/2	15-1/2	5-1/4	68.80	---
875-696F	---	14x14x6	2-3/4	16-1/2	16-3/4	9-3/4	19-3/4	23-3/4	33-1/2	15-1/2	7-1/2	78.50	---
875-698F	---	14x14x8	4-1/4	18-1/2	18-1/4	11-1/4	22-3/4	25-1/4	36-1/2	15-1/2	9-5/8	90.50	---
875-700F	---	14x14x10	5-3/4	19-3/4	19-3/4	12-3/4	25	26-3/4	39-1/2	15-1/2	12	84.58	---
875-702F	---	14x14x12	7-1/4	21-1/8	21-1/4	14-1/4	27-3/8	28-1/4	42-1/2	15-1/2	14-1/8	108.22	---
875-754F	---	16x16x4	5/8	17-1/4	16-5/8	8-5/8	19-1/2	24-5/8	33-1/4	17-3/4	5-1/4	76.47	---
875-756F	---	16x16x6	2-1/8	17-11/16	18-1/8	10-1/8	20-15/16	26-1/8	36-1/4	17-3/4	7-1/2	105.73	---
875-758F	---	16x16x8	3-5/8	19-11/16	19-5/8	11-5/8	23-15/16	27-5/8	39-1/4	17-3/4	9-5/8	120.00	---
875-760F	---	16x16x10	5-1/8	21-1/8	21-1/8	13-1/8	26-3/8	29-1/8	42-1/4	17-3/4	12	137.00	---
875-762F	875-762CF	16x16x12	5-7/8	23-7/8	23-1/8	13-7/8	30-1/8	31-1/8	45	17-3/4	13-5/8	157.00	146.49
875-764F	---	16x16x14	7-7/8	25-1/4	23-7/8	15-7/8	32-1/4	31-7/8	47-3/4	17-3/4	15-1/2	161.25	---
875-786F	---	18x18x6	1-1/2	18-7/8	19-1/2	10-1/2	22-1/8	28-1/2	39	19-7/8	7-1/2	114-13	---
875-788F	---	18x18x8	3	20-3/4	21	12	25	30	42	19-7/8	9-5/8	126.74	---

¹ Outlet sized with bushing

PVC & CPVC SCHEDULE 80 FITTINGS, UNIONS, TANK ADAPTERS, EXPANSION JOINTS & SADDLES

REDUCING WYE

Soc x Soc x Soc

(continued)

1/2" - 2-1/2" 235 psi @ 73°F
 3" - 6" 150 psi @ 73°F
 8" & Up 100 psi @ 73°F

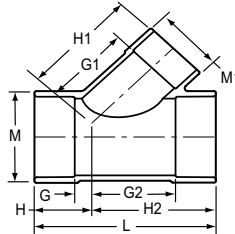

Part Number		Size	G	G1	G2	H	H1	H2	L	M	M1	Approx. Wt. (Lbs.)	
PVC	CPVC											PVC	CPVC
875-790F	---	18x18x10	4-7/16	22-1/2	22-9/16	13-7/16	27-3/4	31-9/16	45	19-7/8	12	141.89	---
875-792F	---	18x18x12	6	23-3/4	24	15	30	33	48	19-7/8	14-1/8	199.00	---
875-794F	---	18x18x14	7	25-7/8	25	16	32-7/8	34	50	19-7/8	15-1/2	225.00	---
875-796F	---	18x18x16	8-5/8	26-1/4	26-3/8	17-5/8	34-1/4	35-3/8	53	19-7/8	17-11/16	225.00	---
875-816F	---	20x20x6	1-3/8	20-1/4	21-3/8	11-3/8	23-1/2	31-3/8	42-3/4	22-1/8	7-1/2	166.39	---
875-818F	---	20x20x8	2-9/16	22-1/4	22-11/16	12-9/16	26-1/2	32-11/16	45-1/4	22-1/8	9-5/8	173.00	---
875-820F	---	20x20x10	4-3/16	23-5/8	24-1/16	14-3/16	28-7/8	34-1/16	48-1/4	22-1/8	12	190.74	---
875-822F	---	20x20x12	5-11/16	25	25-9/16	15-11/16	31-1/4	35-9/16	51-1/4	22-1/8	14-1/8	237.50	---
875-824F	---	20x20x14	7-1/8	27-3/8	27-1/8	17-1/8	34-3/8	37-1/8	54-1/4	22-1/8	15-1/2	243.75	---
875-826F	---	20x20x16	8-5/8	26-1/4	28-5/8	18-5/8	37-1/4	38-5/8	57-1/4	22-1/8	17-3/4	250.00	---
875-828F	---	20x20x18	10-1/8	30-1/8	30-1/8	20-1/8	39-1/8	40-1/8	60-1/4	22-1/8	19-7/8	255.62	---
875-904F	---	24x24x4	-1-1/4	22-3/8	22-3/4	10-3/4	24-5/8	34-3/4	45-1/2	26-1/2	5-1/4	230.78	---
875-906F	---	24x24x6	-1-3/16	22-3/4	25-11/16	10-13/16	26	37-11/16	48-1/2	26-1/2	7-1/2	248.89	---
875-908F	---	24x24x8	1-3/4	24-3/4	25-3/4	13-3/4	29	37-3/4	51-1/2	26-1/2	9-5/8	269.27	---
875-910F	---	24x24x10	3-1/4	27-1/2	27-1/4	15-1/4	32-3/4	39-1/4	54-1/2	26-1/2	12	291.66	---
875-912F	---	24x24x12	4-3/4	27-5/8	28-3/4	16-3/4	33-7/8	40-3/4	57-1/2	26-1/2	14-1/8	264.99	---
875-914F	---	24x24x14	6-1/4	30-1/4	30-1/4	18-1/4	37-1/4	42-1/4	60-1/2	26-1/2	15-1/2	283.70	---
875-916F	---	24x24x16	7-3/4	32-1/8	31-3/4	19-3/4	40-1/8	43-3/4	63-1/2	26-1/2	17-3/4	310.60	---
875-918F	---	24x24x18	9-1/4	33	33-1/4	21-1/4	42	45-1/4	66-1/2	26-1/2	19-7/8	255.60	---
875-920F	---	24x24x20	10-3/4	34-7/8	34-3/4	22-3/4	44-7/8	46-3/4	69-1/2	26-1/2	22-1/2	372.56	---

PVC & CPVC SCHEDULE 80 FITTINGS, UNIONS, TANK ADAPTERS, EXPANSION JOINTS & SADDLES

DOUBLE WYE

Soc x Soc x Soc x Soc

100 psi @ 73°F

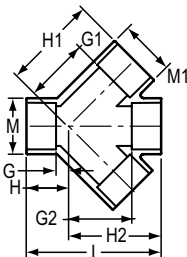

Part Number		Size	G	G1	G2	H	H1	H2	L	M	M1	Approx. Wt. (Lbs.)	
PVC	CPVC											PVC	CPVC
876-020F	876-020CF	2	1-3/4	5	4-13/16	3-1/2	6-3/4	6-9/16	10-1/8	2-13/16	2-13/16	2.97	3.01
876-030F	876-030CF	3	4-7/8	7-9/16	8-3/8	6-3/4	9-7/16	10-1/4	17	4-1/8	4-1/8	6.48	5.84
876-040F	876-040CF	4	5-5/16	10-3/16	9-13/16	7-5/8	12-1/2	12-1/8	19-11/16	5-1/4	5-1/4	9.74	10.32
876-060F	876-060CF	6	5-1/4	11-1/4	11-1/4	8-1/2	14-1/2	14-1/2	23	7-1/2	7-1/2	25.44	28.16
876-080F	876-080CF	8	5-1/16	13-11/16	13-11/16	9-5/16	17-15/16	17-15/16	27-1/4	9-5/8	9-5/8	48.35	49.67
876-100F	876-100CF	10	5-7/8	17-7/8	17-7/8	11-1/8	23-1/8	23-1/8	34-1/4	11-15/16	11-15/16	65.51	94.00
876-120F	876-120CF	12	7-1/8	19-7/8	19-7/8	13-3/8	26-1/8	26-1/8	39-1/2	14-1/8	14-1/8	101.98	149.15

REDUCING DOUBLE WYE

Soc x Soc x Soc x Soc

100 psi @ 73°F

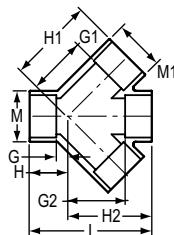

Part Number		Size	G	G1	G2	H	H1	H2	L	M	M1	Approx. Wt. (Lbs.)	
PVC	CPVC											PVC	CPVC
876-338	876-338C	3x2	3/8	4-1/4	4-13/32	2-1/4	5-3/4	5-29/32	8	4-3/16	2-7/8	2.24	2.24
876-528F	876-528CF	6x2	1-7/8	8-5/8	8-5/8	5-1/8	10-3/8	11-7/8	17	7-1/2	2-13/16	10.07	11.45
876-530F	876-530CF	6x3	2-3/4	9-1/2	9-3/4	6	11-3/4	13	19	7-1/2	4-1/8	13.21	12.14
876-532F	876-532CF	6x4	4-1/8	11-1/4	10-3/8	7-3/8	13-1/2	13-5/8	21	7-1/2	5-3/16	18.77	19.78
876-582F	876-582CF	8x4	3	12-1/2	11-1/2	7-1/4	14-3/4	15-3/4	23	9-5/8	5-3/16	20.88	24.78
876-585F	876-585CF	8x6	4-3/4	12-15/16	13-3/4	9	16-3/16	18	27	9-5/8	7-1/2	28.76	31.72
876-621F	876-621CF	10x2	3/8	11-1/8	10-3/4	4-7/8	12-7/8	16	20-7/8	11-15/16	2-13/16	26.48	26.98
876-624F	876-624CF	10x4	1-3/4	16-3/4	12-1/2	7	16-3/4	17-3/4	24-3/4	11-15/16	5-3/16	30.53	34.22
876-628F	876-628CF	10x8	5-1/4	16-1/4	16	10-1/2	20-1/2	21-1/4	31-3/4	12	9-3/4	55.99	60.66
876-666F	876-666CF	12x6	3-1/4	15-1/4	14-3/4	9-1/2	18-1/2	21	30-1/2	14-1/8	7-1/2	50.02	58.24

PVC & CPVC SCHEDULE 80 FITTINGS, UNIONS, TANK ADAPTERS, EXPANSION JOINTS & SADDLES

UNION (Old Style)

Soc x Soc

Dimensions Applicable to

897-XXX EPDM O-ring Seal Units

235 psi @ 73°F

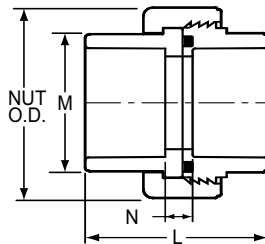

Part Number w/Viton® O-ring Seal		Size	L	M	N	NUT O.D.	Approx. Wt. (Lbs.)	
							PVC	CPVC
857-002	857-002C	1/4	1-15/16	15/16	5/8	1-21/32	.09	.10
857-003	857-003C	3/8	2-5/32	1-1/32	19/32	1-25/32	.11	.11
857-005	857-005C	1/2	2-3/32	1-9/32	11/32	1-31/32	.15	.16
857-007	857-007C	3/4	2-3/8	1-17/32	11/32	2-1/2	.26	.28
857-010	857-010C	1	2-9/16	1-27/32	3/8	2-7/8	.37	.39
857-012	857-012C	1-1/4	2-7/8	2-7/32	3/8	3-5/16	.50	.52
857-015	857-015C	1-1/2	3-3/32	2-9/16	15/32	3-9/16	.60	.63
857-020	857-020C	2	3-5/8	3-1/32	9/16	4-3/16	.96	1.05
857-025	857-025C	2-1/2	4-3/8	3-5/8	15/16	4-7/8	1.51	1.66
857-030	857-030C	3	5-1/16	4-3/8	1-3/16	5-3/4	2.33	2.51
857-040	857-040C	4	5-7/8	5-13/32	1-3/8	7-1/16	3.74	3.98

1) For (Socket X Socket) Unions Equipped With EPDM O-ring, Replace The 857 With An 897 Before The Dash.

e.g. Part Number 897-002 = 1/4" PVC, Union, Socket x Socket, With EPDM O-rings.

UNION (Old Style)

Fipt x Fipt

Dimensions Applicable to

898-XXX EPDM O-ring Seal Units

235 psi @ 73°F

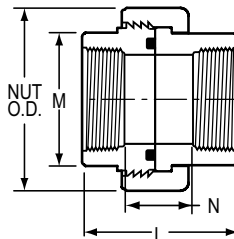

Part Number w/Viton® O-ring Seal		Size	L	M	N	Nut O.D.	Approx. Wt. (Lbs.)	
							PVC	CPVC
858-002	858-002C	1/4	1-15/16	15/16	11/16	1-21/32	.10	.10
858-003	858-003C	3/8	2-5/32	1-1/32	15/16	1-25/32	.12	.13
858-005	858-005C	1/2	2-3/32	1-9/32	19/32	1-31/32	.16	.17
858-007	858-007C	3/4	2-3/8	1-17/32	3/4	2-1/2	.28	.30

PVC & CPVC SCHEDULE 80 FITTINGS, UNIONS, TANK ADAPTERS, EXPANSION JOINTS & SADDLES

UNION (Old Style)

Fipt x Fipt

(continued)

Dimensions Applicable to

898-XXX EPDM O-ring Seal Units

235 psi @ 73°F

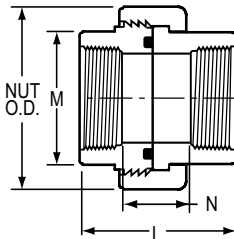

Part Number w/Viton® O-ring Seal		Size	L	M	N	Nut O.D.	Approx. Wt. (Lbs.)	
PVC	CPVC						PVC	CPVC
858-010	858-010C	1	2-9/16	1-27/32	7/16	2-7/8	.39	.41
858-012	858-012C	1-1/4	2-7/8	2-7/32	7/8	3-5/16	.56	.61
858-015	858-015C	1-1/2	3-3/32	2-9/16	1-5/32	3-9/16	.65	.69
858-020	858-020C	2	3-5/8	3-1/32	1-11/16	4-3/16	1.05	1.13
858-025	858-025C	2-1/2	4-3/8	3-5/8	1-7/8	4-7/8	1.67	1.74
858-030	858-030C	3	5-1/16	4-3/8	1-13/16	5-3/4	2.51	2.70
858-040	858-040C	4	5-7/8	5-7/16	2-3/8	7-1/16	4.07	4.30

1) For (Fipt X Fipt) Unions Equipped With EPDM O-ring, Replace The 858 With An 898 Before The Dash.

e.g. Part Number 898-002 = 1/4" PVC, Union, Fipt x Fipt, With EPDM O-rings.

UNION (Old Style)

Soc x Fipt

Dimensions Applicable to

899-XXX EPDM O-ring Seal Units

235 psi @ 73°F

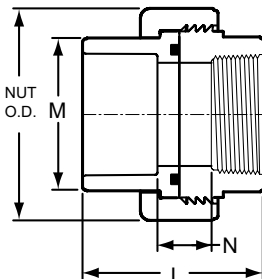

Part Number w/Viton® O-ring Seal		Size	L	M	N	Nut O.D.	Approx. Wt. (Lbs.)	
PVC	CPVC						PVC	CPVC
859-002	---	1/4	1-15/16	15/16	21/32	1-21/32	.08	---
859-003	---	3/8	2-5/32	1-1/32	3/4	1-25/32	.10	---
859-005	859-005C	1/2	2-3/32	1-9/32	15/32	1-31/32	.16	.17
859-007	859-007C	3/4	2-3/8	1-17/32	9/16	2-1/2	.27	.29
859-010	859-010C	1	2-9/16	1-27/32	13/32	2-7/8	.38	.40
859-012	859-012C	1-1/4	2-7/8	2-7/32	5/8	3-5/16	.52	.54
859-015	859-015C	1-1/2	3-1/8	2-19/32	27/32	3-9/16	.63	.66

PVC & CPVC SCHEDULE 80 FITTINGS, UNIONS, TANK ADAPTERS, EXPANSION JOINTS & SADDLES

UNION (Old Style) (continued)

Soc x Fipt
 Dimensions Applicable to
 899-XXX EPDM O-ring Seal Units

235 psi @ 73°F

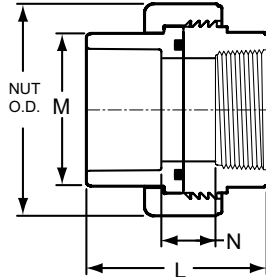

Part Number w/Viton® O-ring Seal		Size	L	M	N	Nut O.D.	Approx. Wt. (Lbs.)	
PVC	CPVC						PVC	CPVC
859-020	859-020C	2	3-5/8	3-1/32	1-1/16	4-3/16	1.00	1.10
859-025	859-025C	2-1/2	4-3/8	3-5/8	1-13/32	4-7/8	1.58	1.66
859-030	859-030C	3	5-1/16	4-3/8	1-1/2	5-3/4	2.42	2.61
859-040	859-040C	4	5-7/8	5-7/16	1-7/8	7-1/16	3.91	4.13

1) For (Socket X Fipt) Unions Equipped With EPDM O-ring, Replace The 859 With An 899 Before The Dash.
 e.g. Part Number 899-002 = 1/4" PVC, Union, Socket x Fipt, With EPDM O-rings.

TRANSITION UNION

Soc x Fipt w/Metal Threaded Insert and Viton® O-ring Seal
 Dimensions Applicable to 899-XXXBR EPDM O-ring Seal Units

235 psi @ 73°F

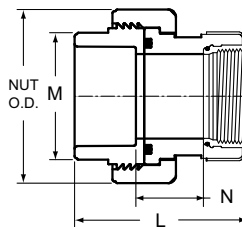

Part Number w/Viton® O-ring Seal		Size	L	M	N	Nut O.D.	Approx. Wt. (Lbs.)	
PVC	CPVC						PVC	CPVC
859-010BR	859-010CBR	1	3-3/32	1-27/32	1-1/32	2-7/8	.54	.55
859-012BR	859-012CBR	1-1/4	3-9/32	2-7/32	1-1/16	3-5/16	.69	.71
859-015BR	859-015CBR	1-1/2	3-1/2	2-9/16	1-3/32	3-17/32	.89	.92
859-020BR	859-020CBR	2	4-3/16	3-1/32	1-5/8	4-3/16	1.33	1.40

1) For (Socket X Fipt) Unions Equipped With EPDM O-ring, Replace The 859 With An 899 Before The Dash.
 e.g. Part Number 899-010BR = 1" PVC, Union Socket x Metal Fipt With EPDM O-rings.

PVC & CPVC SCHEDULE 80 FITTINGS, UNIONS, TANK ADAPTERS, EXPANSION JOINTS & SADDLES

SPECIAL REINFORCED UNION (Old style)

Soc x SR Fipt

Dimensions Applicable to

899-XXXSR EPDM O-ring Seal Units

235 psi @ 73°F

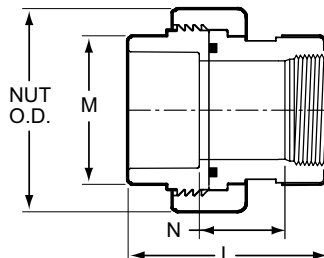

Part Number w/Viton® O-ring Seal		Size	L	M	N	Nut O.D.	Approx. Wt. (Lbs.)	
PVC	CPVC						PVC	CPVC
859-002SR	859-002CSR	1/4	2-1/16	15/16	25/32	1-21/32	.09	.10
859-003SR	859-003CSR	3/8	2-5/16	1-1/32	29/32	1-25/32	.06	.07
859-005SR	859-005CSR	1/2	2-9/32	1-9/32	21/32	1-31/32	.17	.19
859-007SR	859-007CSR	3/4	2-19/32	1-17/32	25/32	2-1/2	.28	.27
859-010SR	859-010CSR	1	2-15/16	1-27/32	25/32	2-7/8	.40	.42
859-012SR	859-012CSR	1-1/4	3-5/32	2-7/32	29/32	3-5/16	.55	.59
859-015SR	859-015CSR	1-1/2	3-13/32	2-9/16	1-1/32	3-9/16	.67	.71
859-020SR	859-020CSR	2	4-3/32	3-1/32	1-19/32	4-3/16	1.12	1.21
859-030SR	859-030CSR	3	5-1/4	4-3/8	1-11/16	5-3/4	2.50	2.60
859-040SR	859-040CSR	4	5-7/8	5-7/16	1-7/8	7-1/16	3.96	4.20

1) For (Socket X SR Fipt) Unions Equipped With EPDM O-ring, Replace The 859 With An 899 Before The Dash.

e.g. Part Number 899-002SR = 1/4" PVC, Union, Socket x SR Fipt, With EPDM O-rings.

UNION 2000

Soc x Soc

Dimensions Applicable to

8097-XXX EPDM O-ring Seal Units

1/2" - 4" 235 psi @ 73°F

6" 150 psi @ 73°F

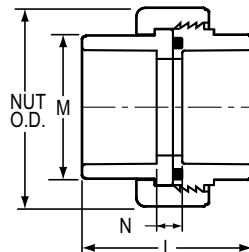

Part Number w/Viton® O-ring Seal		Size	L	M	N	Nut O.D.	Approx. Wt. (Lbs.)	
PVC	CPVC						PVC	CPVC
8057-005	8057-005C	1/2	2-3/32	1-3/16	11/32	1-7/8	.12	.08
8057-007	8057-007C	3/4	2-3/8	1-13/32	3/8	2-9/32	.17	.19
8057-010	8057-010C	1	2-11/16	1-23/32	7/16	2-9/16	.28	.17
8057-012	8057-012C	1-1/4	2-15/16	2-3/32	7/16	3-3/32	.36	.40

PVC & CPVC SCHEDULE 80 FITTINGS, UNIONS, TANK ADAPTERS, EXPANSION JOINTS & SADDLES

UNION 2000

(continued)

Soc x Soc

Dimensions Applicable to
8097-XXX EPDM O-ring Seal Units

1/2" - 4" 235 psi @ 73°F
6" 150 psi @ 73°F

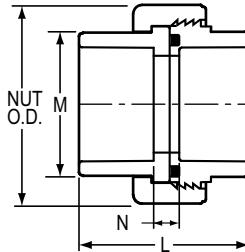

Part Number w/Viton® O-ring Seal		Size	L	M	N	Nut O.D.	Approx. Wt. (Lbs.)	
PVC	CPVC						PVC	CPVC
8057-015	8057-015C	1-1/2	3-1/4	2-3/8	1/2	3-1/2	.50	.51
8057-020	8057-020C	2	3-17/32	2-7/8	17/32	4-9/32	.86	.89
8057-025	8057-025C	2-1/2	4-7/32	3-1/2	11/16	6-5/32	1.51	1.66
8057-030	8057-030C	3	4-1/4	4-3/16	1/2	6-5/32	2.16	2.50
8057-040	8057-040C	4	5-1/8	5-1/4	5/8	7-3/4	3.75	3.97
8057-060	8057-060C	6	6-27/32	7-1/2	25/32	11-5/8	10.38	10.88

UNION 2000

Fipt x Fipt

Dimensions Applicable to
8098-XXX EPDM O-ring Seal Units

1/2" - 4" 235 psi @ 73°F
6" 150 psi @ 73°F

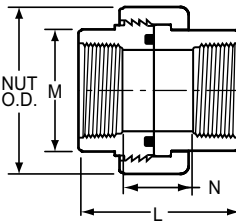

Part Number w/Viton® O-ring Seal		Size	L	M	N	Nut O.D.	Approx. Wt. (Lbs.)	
PVC	CPVC						PVC	CPVC
8058-005	8058-005C	1/2	1-29/32	1-3/16	17/32	1-7/8	.08	.08
8058-007	8058-007C	3/4	2-1/16	1-3/8	9/16	2-9/32	.17	.18
8058-010	8058-010C	1	2-17/32	1-11/16	25/32	2-9/16	.21	.11
8058-012	8058-012C	1-1/4	2-21/32	2-1/32	3/4	3-1/8	.38	.40
8058-015	8058-015C	1-1/2	2-25/32	2-3/8	29/32	3-1/2	.53	.50
8058-020	8058-020C	2	3-1/8	3	1-3/16	4-7/32	.89	.94
8058-025	8058-025C	2-1/2	4-1/32	3-9/16	1-15/32	6-5/32	1.67	1.74
8058-030	8058-030C	3	4-5/32	4-9/32	1-13/32	6-5/32	2.37	2.50
8058-040	8058-040C	4	4-21/32	5-1/4	1-21/32	7-3/4	3.59	4.03
8058-060	8058-060C	6	6-1/8	7-21/32	2-13/16	11-19/32	12.10	11.96

PVC & CPVC SCHEDULE 80 FITTINGS, UNIONS, TANK ADAPTERS, EXPANSION JOINTS & SADDLES

SPECIAL REINFORCED UNION 2000

SR Fipt x SR Fipt

Dimensions Applicable to

8098-XXXXSR EPDM O-ring Seal Units

1/2" - 4" 235 psi @ 73°F
6" 150 psi @ 73°F

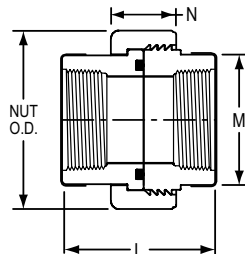

Part Number w/Viton® O-ring Seal		Size	L	M	N	Nut O.D.	Approx. Wt. (Lbs.)	
PVC	CPVC						PVC	CPVC
8058-005SR	8058-005CSR	1/2	2	1-3/16	5/8	1-7/8	.14	.14
8058-007SR	8058-007CSR	3/4	2-5/32	1-3/8	21/32	2-9/32	.15	.20
8058-010SR	8058-010CSR	1	2-9/16	1-11/16	13/16	2-9/16	.21	.24
8058-012SR	8058-012CSR	1-1/4	2-23/32	2-1/32	13/16	3-1/8	.39	.41
8058-015SR	8058-015CSR	1-1/2	2-3/4	2-3/8	7/8	3-1/2	.59	.56
8058-020SR	8058-020CSR	2	3-7/32	3-1/32	1-3/16	4-7/32	.97	1.02
8058-025SR	8058-025CSR	2-1/2	4-3/32	3-9/16	1-15/32	6-5/32	1.66	1.73
8058-030SR	8058-030CSR	3	4-3/16	4-9/32	1-3/8	6-5/32	2.44	2.50
8058-040SR	8058-040CSR	4	4-11/16	5-1/4	1-11/16	7-3/4	3.73	4.17
8058-060SR	8058-060CSR	6	6-3/16	7-11/16	2-13/16	11-5/8	10.98	11.54

UNION 2000

Soc x Fipt

Dimensions Applicable to

8099-XXX EPDM O-ring Seal Units

1/2" - 4" 235 psi @ 73°F
6" 150 psi @ 73°F

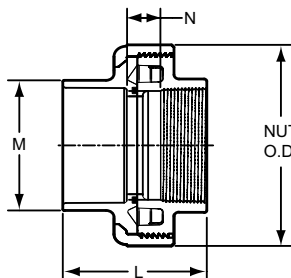

Part Number w/Viton® O-ring Seal		Size	L	M	N	Nut O.D.	Approx. Wt. (Lbs.)	
PVC	CPVC						PVC	CPVC
8059-005	8059-005C	1/2	1-7/8	1-3/16	5/16	1-7/8	.11	.08
8059-007	8059-007C	3/4	2-1/16	1-13/32	5/16	2-9/32	.18	.19
8059-010	8059-010C	1	2-13/32	1-23/32	13/32	2-9/16	.20	.09
8059-012	8059-012C	1-1/4	2-19/32	2-3/32	13/32	3-1/8	.35	.37
8059-015	8059-015C	1-1/2	2-13/16	2-3/8	1/2	3-1/2	.49	.50

PVC & CPVC SCHEDULE 80 FITTINGS, UNIONS, TANK ADAPTERS, EXPANSION JOINTS & SADDLES

UNION 2000

Soc x Fipt

(continued)

Dimensions Applicable to

8099-XXX EPDM O-ring Seal Units

1/2" - 4" 235 psi @ 73°F
6" 150 psi @ 73°F

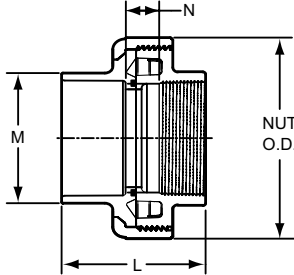

Part Number w/Viton® O-ring Seal		Size	L	M	N	Nut O.D.	Approx. Wt. (Lbs.)	
PVC	CPVC						PVC	CPVC
8059-020	8059-020C	2	2-31/32	2-7/8	13/32	4-9/32	.92	.96
8059-025	8059-025C	2-1/2	3-15/32	3-1/2	13/32	6-3/16	1.58	1.66
8059-030	8059-030C	3	3-25/32	4-3/16	17/32	6-5/32	2.17	2.32
8059-040	8059-040C	4	4-3/8	5-1/4	5/8	7-3/4	3.64	3.83
8059-060	8059-060C	6	6-27/32	7-1/2	1-1/2	11-5/8	11.69	11.80

UNION 2000

Soc x SR Fipt

Dimensions Applicable to

8099-XXXSR EPDM O-ring Seal Units

1/2" - 4" 235 psi @ 73°F
6" 150 psi @ 73°F

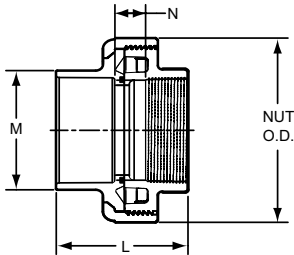

Part Number w/Viton® O-ring Seal		Size	L	M	N	Nut O.D.	Approx. Wt. (Lbs.)	
PVC	CPVC						PVC	CPVC
8059-005SR	8059-005CSR	1/2	1-29/32	1-3/16	11/32	1-7/8	.12	.09
8059-007SR	8059-007CSR	3/4	2-5/32	1-13/32	13/32	2-9/32	.14	.20
8059-010SR	8059-010CSR	1	2-7/16	1-23/32	7/16	2-9/16	.20	.20
8059-012SR	8059-012CSR	1-1/4	2-5/8	2-3/32	7/16	3-1/8	.37	.39
8059-015SR	8059-015CSR	1-1/2	2-13/16	2-3/8	1/2	3-1/2	.56	.56
8059-020SR	8059-020CSR	2	3	2-7/8	7/16	4-7/32	1.00	1.04
8059-025SR	8059-025CSR	2-1/2	3-15/32	3-1/2	13/32	4-7/8	1.57	1.65
8059-030SR	8059-030CSR	3	3-3/4	4-3/16	1/2	6-9/32	2.24	2.38
8059-040SR	8059-040CSR	4	4-3/8	5-1/4	5/8	7-3/4	2.81	2.95
8059-060SR	8059-060CSR	6	6-27/32	7-1/2	2-5/32	11-5/8	11.50	11.95

PVC & CPVC SCHEDULE 80 FITTINGS, UNIONS, TANK ADAPTERS, EXPANSION JOINTS & SADDLES

UNION 2000

Soc x Spig

Dimensions Applicable to

8096-XXX EPDM O-ring Seal Units

1/2" - 4" 235 psi
6" 150 psi

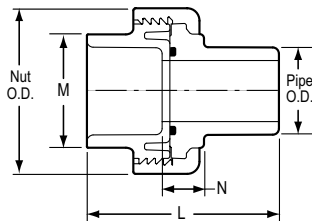

Part Number w/Viton® O-ring Seal		Size	L	M	N	Nut O.D.	Approx. Wt. (Lbs.)	
PVC	CPVC						PVC	CPVC
8056-005	8056-005C	1/2	2-5/16	1-3/16	9/16	1-7/8	.12	.13
8056-007	8056-007C	3/4	2-5/8	1-3/8	9/16	2-1/4	.19	.20
8056-010	8056-010C	1	2-15/16	1-23/32	5/8	2-9/16	.29	.30
8056-012	8056-012C	1-1/4	3-3/16	2-3/32	5/8	3-3/32	.38	.41
8056-015	8056-015C	1-1/2	3-1/2	2-3/8	11/16	3-9/16	.50	.54
8056-020	8056-020C	2	3-3/4	2-7/8	3/4	4-5/16	.81	.85
8056-025	8056-025C	2-1/2	4-5/8	3-15/32	1-1/8	6-5/32	2.18	2.30
8056-030	8056-030C	3	4-11/16	4-3/16	15/16	6-5/32	2.35	2.40
8056-040	8056-040C	4	5-5/8	5-7/32	1-1/8	7-3/4	3.79	4.04
8056-060	8056-060C	6	7-3/4	7-9/16	1-1/2	11-11/16	11.84	12.68

PVC TRANSITION UNION

DIN (mm) SOC x ASTM (in) SOC

Dimensions Applicable to 8697-XXX EPDM O-ring Seal Units

235 psi @ 73°F
(PN 16 @ 22°C)

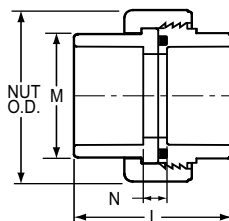

Part Number w/Viton® O-ring Seal	Size	L	M	N	Nut O.D.	Approx. Wt. (Lbs.)
8657-020	20d x 1/2	2-1/16	1-9/32	5/16	1-31/32	.16
8657-025	25d x 3/4	2-11/32	1-17/32	11/32	2-1/2	.27
8657-032	32d x 1	2-9/16	1-27/32	3/8	2-7/8	.37
8657-040	40d x 1-1/4	2-7/8	2-7/32	3/8	3-5/16	.52
8657-050	50d x 1-1/2	3-1/8	2-9/16	5/16	3-9/16	.59
8657-063	63d x 2	3-5/8	3-1/32	9/16	4-3/16	.94
8657-090	90d x 3	5-1/16	4-3/8	1-3/16	5-3/4	2.31
8657-110	110d x 4	5-7/8	5-7/16	1-3/8	7-1/16	3.91

1) For DIN (mm) SOC X ASTM (in) SOC Unions Equipped with EPDM O-ring, Replace The 8657 With An 8697 Before The Dash.
e.g. Part Number 8697-020 = 20mm x 1/2" PVC, Union Socket x Socket With EPDM O-rings.

PVC & CPVC SCHEDULE 80 FITTINGS, UNIONS, TANK ADAPTERS, EXPANSION JOINTS & SADDLES

PVC TRANSITION UNION

DIN (mm) SOC x ASTM (in) Fipt

Dimensions Applicable to 8698-XXX EPDM O-ring Seal Units

235 psi @ 73°F
(PN 16 @ 22°C)

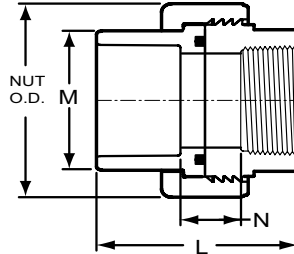

Part Number w/Viton® O-ring Seal	Size	L	M	N	Nut O.D.	Approx. Wt. (Lbs.)
8658-020	20d x 1/2	2-3/32	1-9/32	19/32	1-31/32	.16
8658-025	25d x 3/4	2-3/8	1-17/32	3/4	2-1/2	.28
8658-032	32d x 1	2-9/16	1-27/32	7/16	2-7/8	.38
8658-040	40d x 1-1/4	2-7/8	2-7/32	7/8	3-5/16	.56
8658-050	50d x 1-1/2	3-3/32	2-9/16	1-5/32	3-9/16	.61
8658-063	63d x 2	3-9/16	3-1/32	1-5/8	4-3/16	.99
8658-090	90d x 3	5-1/16	4-3/8	1-13/16	5-3/4	2.41
8658-110	110d x 4	5-7/8	5-7/16	2-3/8	7-1/16	4.07

1) For DIN (mm) SOC X NPT (in) Fipt Unions Equipped with EPDM O-ring, Replace The 8658 With An 8698 Before The Dash.
e.g. Part Number 8698-020 = 20mm x 1/2" PVC, Union, DIN Socket x ASTM Fipt With EPDM O-rings.

PVC TRANSITION UNION

JIS (mm) SOC X ASTM (in) SOC

Dimensions Applicable to 8297-XXX EPDM O-ring Seal Units

235 psi @ 73°F
(PN 16 @ 22°C)

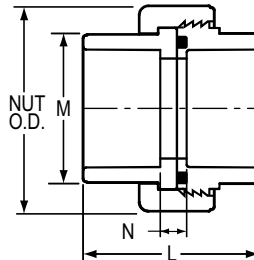

Part Number w/Viton® O-ring Seal	Size	L	M	N	Nut O.D.	Approx. Wt. (Lbs.)
8257-016	16DN x 1/2	2-1/16	1-9/32	5/16	1-31/32	.15
8257-020	20DN x 3/4	2-3/8	1-17/32	5/16	2-1/2	.26
8257-025	25DN x 1	2-9/16	1-27/32	3/8	2-7/8	.37
8257-030	30DN x 1-1/4	2-27/32	2-7/32	11/32	3-5/16	.53
8257-040	40DN x 1-1/2	3-1/8	2-9/16	5/16	3-9/16	.61
8257-050	50DN x 2	3-5/8	3-1/32	9/16	4-3/16	.97
8257-075	75DN x 3	5-1/16	4-3/8	1-3/16	5-3/4	2.34
8257-100	100DN x 4	5-7/8	5-7/16	1-3/8	7-1/16	3.80

1) For JIS (mm) SOC X ASTM (in) SOC Unions Equipped with EPDM O-ring, Replace The 8257 With An 8297 Before The Dash.
e.g. Part Number 8297-016 = 16mm x 1/2" PVC, Union, JIS Socket x ASTM Socket With EPDM O-rings.

PVC & CPVC SCHEDULE 80 FITTINGS, UNIONS, TANK ADAPTERS, EXPANSION JOINTS & SADDLES

PVC TRANSITION UNION

JIS (mm) SOC X ASTM (in) Fipt

Dimensions Applicable to 8298-XXX EPDM O-ring Seal Units

235 psi @ 73°F
(PN 16 @ 22°C)

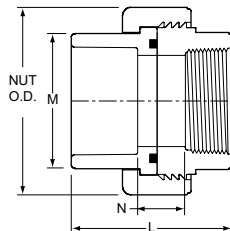

Part Number w/Viton® O-ring Seal	Size	L	M	N	Nut O.D.	Approx. Wt. (Lbs.)
8258-016	16DN x 1/2	2-3/32	1-9/32	19/32	1-31/32	.16
8258-020	20DN x 3/4	2-3/8	1-17/32	3/4	2-1/2	.27
8258-025	25DN x 1	2-9/16	1-27/32	7/16	2-7/8	.38
8258-030	30DN x 1-1/4	2-7/8	2-7/32	7/8	3-5/16	.57
8258-040	40DN x 1-1/2	3-3/32	2-9/16	1-5/32	3-9/16	.63
8258-050	50DN x 2	3-9/16	3-1/32	1-5/8	4-3/16	1.02
8258-075	75DN x 3	5-1/16	4-3/8	1-13/16	5-3/4	2.43
8258-100	100DN x 4	5-7/8	5-7/16	2-3/8	7-1/16	3.96

1) For JIS (mm) SOC X ASTM (in) Fipt Unions Equipped with EPDM O-ring, Replace The 8258 With An 8298 Before The Dash.
e.g. Part Number 8298-016 = 16dn x 1/2" PVC, Union, JIS Socket x ASTM Fipt With EPDM O-rings.

PVC TRANSITION UNION

BSP Threaded x ASTM (in) SOC

Dimensions Applicable to 8399-XXX EPDM O-ring Seal Units

235 psi @ 73°F
(PN 16 @ 22°C)

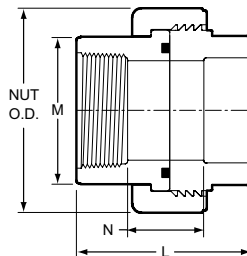

Part Number w/Viton® O-ring Seal	Size	L	M	N	Nut O.D.	Approx. Wt. (Lbs.)
8359-005	1/2	2-3/32	1-9/32	15/32	1-31/32	.16
8359-007	3/4	2-3/8	1-17/32	9/16	2-1/2	.27
8359-010	1	2-9/16	1-27/32	13/32	2-7/8	.38
8359-012	1-1/4	2-7/8	2-7/32	5/8	3-5/16	.52
8359-015	1-1/2	3-3/32	2-9/16	23/32	3-9/16	.62
8359-020	2	3-5/8	3-1/32	1-1/8	4-3/16	1.00
8359-030	3	5-1/16	4-3/8	1-1/2	5-3/4	2.43
8359-040	4	5-7/8	5-7/16	1-7/8	7-1/16	3.84

1) For BSP Threaded X ASTM (in) SOC Unions Equipped with EPDM O-ring, Replace The 8359 With An 8399 Before The Dash.
e.g. Part Number 8399-005 = 1/2" PVC, Union, BSP Thread x ASTM Socket With EPDM O-rings.

PVC & CPVC SCHEDULE 80 FITTINGS, UNIONS, TANK ADAPTERS, EXPANSION JOINTS & SADDLES

PVC TRANSITION UNION

BSP Threaded x ASTM (in.) Fipt
 Dimensions Applicable to
 8398-XXX EPDM O-ring Seal Units

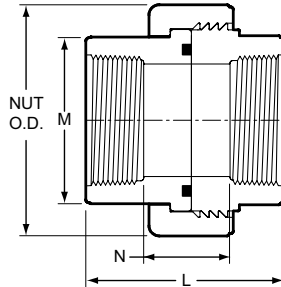

Part Number w/Viton® O-ring Seal	Size	L	M	N	Nut O.D.	Approx. Wt. (Lbs.)
8358-005	1/2	2-3/32	1-9/32	19/32	1-31/32	.16
8358-007	3/4	2-3/8	1-17/32	3/4	2-1/2	.28
8358-010	1	2-9/16	1-27/32	7-16	2-7/8	.39
8358-012	1-1/4	2-7/8	2-7/32	7/8	3-5/16	.56
8358-015	1-1/2	3-3/32	2-9/16	1-5/32	3-9/16	.64
8358-020	2	3-9/16	3-1/32	1-5/8	4-3/16	1.05
8358-030	3	5-1/16	4-3/8	1-13/16	5-3/4	2.52
8358-040	4	5-7/8	5-7/16	2-3/8	7-1/16	4.00

1) For BSP Threaded X ASTM Fipt Unions Equipped with EPDM O-ring, Replace The 8358 With An 8398 Before The Dash.
 e.g. Part Number 8398-005 = 1/2" PVC, Union, BSP Thread x ASTM Fipt With EPDM O-rings.

NEW STYLE - TANK ADAPTER

Soc x Soc
 Applicable to 8170E-XXX & 8170V-XXX

150 psi @ 73°F

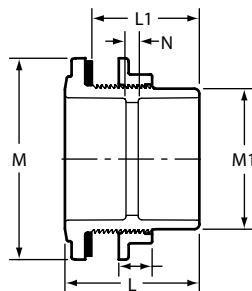

Part Number		Size	L	L1	M	M1	N	R	Approx. Wt. (Lbs.)	
PVC	CPVC								PVC	CPVC
8170-002	8170-002C	1/4	2-1/2	1-13/16	1-1/2	1-1/16	1-3/16	1/2	.10	.11
8170-003	8170-003C	3/8	2-1/2	1-13/16	1-5/8	1-3/16	1	1/2	.11	.12
8170-005	8170-005C	1/2	2-15/16	2-3/16	2	1-7/16	1-1/8	5/8	.22	.23
8170-007	8170-007C	3/4	2-15/16	2-3/16	2-1/4	1-5/8	15/16	5/8	.26	.27
8170-010	8170-010C	1	3-5/16	2-9/16	2-5/8	2	1-1/16	5/8	.37	.41
8170-012	8170-012C	1-1/4	3-7/16	2-5/8	3-1/8	2-5/16	15/16	5/8	.42	.45

PVC & CPVC SCHEDULE 80 FITTINGS, UNIONS, TANK ADAPTERS, EXPANSION JOINTS & SADDLES

NEW STYLE - TANK ADAPTER (continued)

Soc x Soc

Applicable to 8170E-XXX & 8170V-XXX

(continued)

150 psi @ 73°F

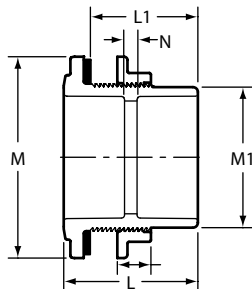

Part Number		Size	L	L1	M	M1	N	R	Approx. Wt. (Lbs.)	
									PVC	CPVC
8170-015	8170-015C	1-1/2	3-5/8	2-13/16	3-5/8	2-11/16	13/16	5/8	.98	1.04
8170-020	8170-020C	2	4-1/8	3-1/4	4-7/8	3-1/4	1-1/16	3/4	1.28	1.33
8170-025	8170-025C	2-1/2	4-7/8	3-7/8	5-1/4	3-13/16	1-5/16	1	---	---
8170-030	8170-030C	3	5-1/2	4-1/2	6	4-9/16	1-11/16	1	2.62	2.69
8170-040	8170-040C	4	5	4	7-1/2	5-1/2	7/16	1-1/4	3.13	3.40
8170-080	8170-080C	8	8-5/8	7	12-15/16	10-1/4	1/2	1-1/2	16.02	17.30

Tank Adapter Referenced Dimension Tolerance = $\pm 1/16$ "

NEW STYLE - TANK ADAPTER

Soc x Fipt

Applicable to 8171E-XXX & 8171V-XXX

150 psi @ 73°F

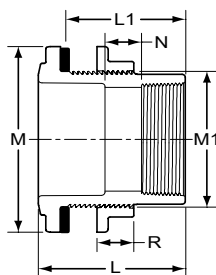

Part Number		Size	L	L1	M	M1	N	R	Approx. Wt. (Lbs.)	
									PVC	CPVC
8171-002	8171-002C	1/4	2-1/2	1-13/16	1-1/2	1-1/16	1-1/4	1/2	.10	.11
8171-003	8171-003C	3/8	2-1/2	1-13/16	1-5/8	1-3/16	1-3/16	1/2	.11	.12
8171-005	8171-005C	1/2	2-29/32	2-7/16	2-1/32	1-7/32	1-1/2	5/8	.22	.23
8171-007	8171-007C	3/4	2-15/16	2-15/32	2-1/4	1-5/8	1-3/16	5/8	.25	.26
8171-010	8171-010C	1	3-5/16	2-13/16	2-5/8	1-31/32	1-1/4	5/8	.36	.38
8171-012	8171-012C	1-1/4	3-13/32	2-27/32	3-3/32	2-5/16	1-17/32	5/8	.50	.53
8171-015	8171-015C	1-1/2	3-5/8	2-13/16	3-5/8	2-11/16	1-1/4	5/8	.67	.71
8171-020	8171-020C	2	4-1/8	3-1/4	4-7/8	3-1/4	1-5/8	3/4	1.32	1.34

PVC & CPVC SCHEDULE 80 FITTINGS, UNIONS, TANK ADAPTERS, EXPANSION JOINTS & SADDLES

NEW STYLE - TANK ADAPTER (continued)

Soc x Fipt
Applicable to 8171E-XXX & 8171V-XXX

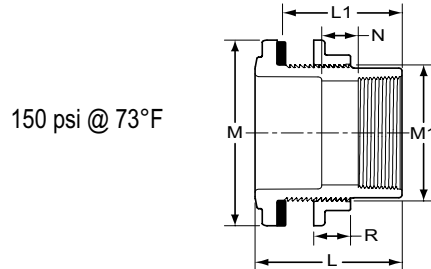

Part Number		Size	L	L1	M	M1	N	R	Approx. Wt. (Lbs.)	
PVC	CPVC								PVC	CPVC
8171-025	8171-025C	2-1/2	4-7/8	7/8	5-1/4	3-13/16	1-13/16	1	1.78	1.92
8171-030	8171-030C	3	5-1/2	4-1/2	6	4-9/16	2-3/16	1	2.61	2.80
8171-040	8171-040C	4	5	4	7-1/2	5-1/2	1-1/4	1-1/4	3.24	3.36

NEW STYLE - TANK ADAPTER

Soc x SR Fipt
Applicable to 8171E-XXXSR & 8171V-XXXSR

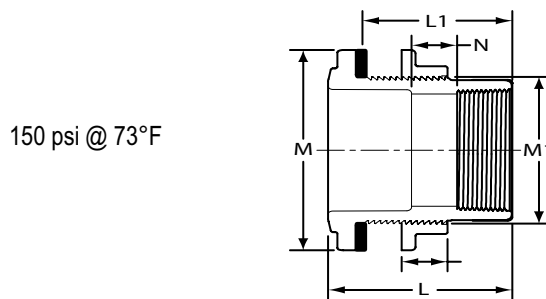

Part Number		Size	L	L1	M	M1	N	R	Approx. Wt. (Lbs.)	
PVC	CPVC								PVC	CPVC
8171-002SR	8171-002CSR	1/4	2-1/2	1-13/16	1-1/2	1-1/16	1-1/4	1/2	.11	.11
8171-003SR	8171-003CSR	3/8	2-1/2	1-13/16	1-5/8	1-3/16	1-3/16	1/2	.12	.13
8171-005SR	8171-005CSR	1/2	2-15/16	2-7/16	2-1/32	1-15/32	1-9/32	5/8	.22	.24
8171-007SR	8171-007CSR	3/4	2-15/16	2-3/16	2-1/4	1-5/8	1-1/4	5/8	.26	.28
8171-010SR	8171-010CSR	1	3-5/16	2-13/16	2-5/8	1-31/32	1-1/4	5/8	.36	.38
8171-012SR	8171-012CSR	1-1/4	3-13/32	2-5/8	3-3/32	2-5/16	1-17/32	5/8	.50	.53
8171-015SR	8171-015CSR	1-1/2	3-5/8	2-13/16	3-5/8	2-11/16	1-1/4	5/8	.70	.74
8171-020SR	8171-020CSR	2	4-1/8	3-1/4	4-7/8	3-1/4	1-5/8	3/4	1.36	1.70
8171-025SR	8171-025CSR	2-1/2	4-7/8	3-7/8	5-1/4	3-13/16	1-11/16	1	1.90	1.99
8171-030SR	8171-030CSR	3	5-1/2	4-1/2	6	4-9/16	2-3/16	1	2.78	2.82
8171-040SR	8171-040CSR	4	5	4	7-1/2	5-1/2	1-1/4	1-1/4	3.60	4.45

PVC & CPVC SCHEDULE 80 FITTINGS, UNIONS, TANK ADAPTERS, EXPANSION JOINTS & SADDLES

NEW STYLE - TANK ADAPTER

Fipt x Fipt

Applicable to 8172E-XXX & 8172V-XXX

150 psi @ 73°F

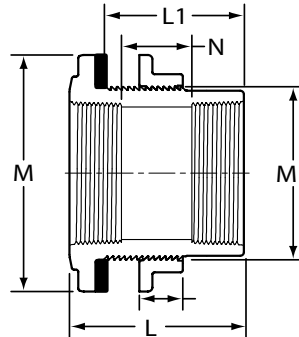

Part Number		Size	L	L1	M	M1	N	R	Approx. Wt. (Lbs.)	
PVC	CPVC								PVC	CPVC
8172-002	8172-002C	1/4	2-1/2	1-13/16	1-1/2	1-1/16	1-5/16	1/2	---	---
8172-003	8172-003C	3/8	2-1/2	1-13/16	1-5/8	1-3/16	1-3/8	1/2	---	---
8172-005	8172-005C	1/2	2-15/16	2-3/16	2	1-7/16	1-1/2	5/8	---	---
8172-007	8172-007C	3/4	2-15/16	2-15/32	2-1/4	1-5/8	1-1/2	5/8	.25	.26
8172-010	8172-010C	1	3-5/16	2-13/16	2-5/8	1-31/32	1-1/4	5/8	.36	.38
8172-012	8172-012C	1-1/4	3-13/32	2-27/32	3-3/32	2-5/16	1-17/32	5/8	.50	.53
8172-015	8172-015C	1-1/2	3-19/32	3-1/16	3-19/32	2-21/32	1-11/16	5/8	.68	.72
8172-020	8172-020C	2	4-1/8	3-1/4	4-7/8	3-1/4	2-3/16	3/4	1.34	1.42
8172-025	8172-025C	2-1/2	4-7/8	3-7/8	5-1/4	3-13/16	2-1/4	1	1.91	2.06
8172-030	8172-030C	3	5-1/2	4-1/2	6	4-9/16	2-11/16	1	2.80	2.95
8172-040	8172-040C	4	5	4	7-1/2	5-1/2	2	1-1/4	3.53	3.70
8172-060	8172-060C	6	5	4-3/16	9-7/8	7-31/32	1-5/32	1-1/4	5.90	6.21

PVC & CPVC SCHEDULE 80 FITTINGS, UNIONS, TANK ADAPTERS, EXPANSION JOINTS & SADDLES

NEW STYLE - TANK ADAPTER

Fipt x SR Fipt

Applicable to 8172E-XXXSR & 8172V-XXXSR

150 psi @ 73°F

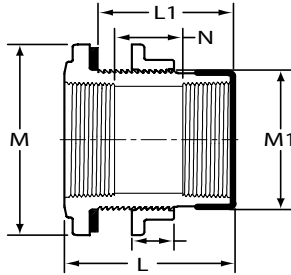

Part Number		Size	L	L1	M	M1	N	R	Approx. Wt. (Lbs.)	
PVC	CPVC								PVC	CPVC
8172-002SR	8172-002CSR	1/4	2-1/2	1-7/8	1-9/16	1-1/16	1-5/16	1/2	.12	.13
8172-003SR	8172-003CSR	3/8	2-1/2	1-13/16	1-5/8	1-3/16	1-3/8	1/2	.14	.15
8172-005SR	8172-005CSR	1/2	2-15/16	2-3/16	2	1-7/16	1-1/2	5/8	.24	.25
8172-007SR	8172-007CSR	3/4	2-15/16	2-15/32	2-1/4	1-5/8	1-3/16	5/8	.26	.25
8172-010SR	8172-010CSR	1	3-15/16	2-19/32	2-5/8	1-31/32	1-1/4	5/8	.38	.36
8172-012SR	8172-012CSR	1-1/4	3-13/32	2-27/32	3-3/32	2-5/16	1-17/32	5/8	.50	.53
8172-015SR	8172-015CSR	1-1/2	3-5/8	2-13/16	3-5/8	2-11/16	1-3/4	5/8	.73	.77
8172-020SR	8172-020CSR	2	4-1/8	3-1/4	4-27/32	3-1/32	2-1/8	3/4	1.34	1.41
8172-025SR	8172-025CSR	2-1/2	4-7/8	3-7/8	5-1/4	3-13/16	2-1/4	1	1.97	2.11
8172-030SR	8172-030CSR	3	5-15/32	4-17/32	5-31/32	4-17/32	2-21/32	1	2.87	3.02
8172-040SR	8172-040CSR	4	5	4	7-1/2	5-1/2	2	1-1/4	3.61	3.80

TANK ADAPTER GASKET SECTION	SIZE	OD*	ID*	T
	1/4	1.49	0.99	1/4
	3/8	1.62	1.12	1/4
	1/2	1.98	1.41	1/4
	3/4	2.20	1.57	1/4
	1	2.60	1.90	1/4
	1-1/4	3.04	2.23	1/4
	1-1/2	3.54	2.57	1/4
	2	4.76	3.15	1/4
	2-1/2	5.13	3.70	1/4
	3	5.86	4.39	1/4
	4	7.34	5.31	1/4
	6	9.85	7.95	3/16
	8	12.70	9.94	3/8

New Style Tank Adapter Gasket & Hole Size Requirements			
Tank Adapter Size	Recommended Minimum Hole Size	Minimum Inside Curvature Radius (inches)	Maximum Tank Wall Thickness (inches)
1/4	1-1/16	2.50	0.50
3/8	1-3/16	3.00	0.50
1/2	1-1/2	4.00	0.75
3/4	1-3/4	5.00	0.75
1	2	7.00	0.86
1-1/4	2-3/8	9.50	0.86
1-1/2	2-3/4	12.00	0.86
2	3-3/8	18.50	1.19
2-1/2	3-7/8	23.50	1.50
3	4-5/8	32.50	2.00
4	5-1/2	43.50	1.25
6	8	79.50	2.06
8	10-3/8	98.00	4.25

* Both outside and inside dimensions are +/- .01 to .03 shore hardness 50-60

PVC & CPVC SCHEDULE 80 FITTINGS, UNIONS, TANK ADAPTERS, EXPANSION JOINTS & SADDLES

OLD STYLE - TANK ADAPTER

Soc x Fipt

Applicable to 871E-XXX

150 psi @ 73°F

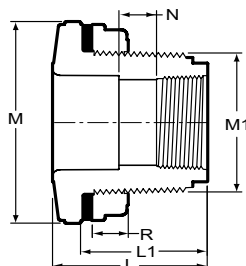

Part Number		Size	L	L1	M	M1	N	R	Approx. Wt. (Lbs.)	
PVC	CPVC								PVC	CPVC
871-005	871-005C	1/2	2-27/32	2-11/32	2-9/32	1-9/32	1-3/8	5/8	.24	.26
871-007	871-007C	3/4	2-23/32	2-7/32	2-1/2	1-5/8	29/32	5/8	.30	.32
871-010	871-010C	1	2-25/32	2-1/8	2-13/16	1-7/8	25/32	21/32	.34	.34
871-012	871-012C	1-1/4	3-1/8	2-7/16	3-29/32	2-11/32	27/32	5/8	.64	.63
871-015	871-015C	1-1/2	3-5/32	2-21/32	3-29/32	2-11/32	3/4	5/8	.55	.59
871-020	871-020C	2	3-3/16	2-17/32	4-31/32	3-15/32	13/16	3/4	1.33	1.43
871-030	871-030C	3	4-19/32	3-13/16	6-7/16	4-15/32	31/32	1-3/16	2.47	2.63
871-040	871-040C	4	4-7/16	3-23/32	7-7/16	5-1/2	1/2	1-1/4	3.17	3.37
871-060	871-060C	6	4-31/32	4-3/16	9-7/8	7-31/32	1/32	1-1/4	5.59	5.92

OLD STYLE - TANK ADAPTER

Fipt x Fipt

Applicable to 872E-XXX

150 psi @ 73°F

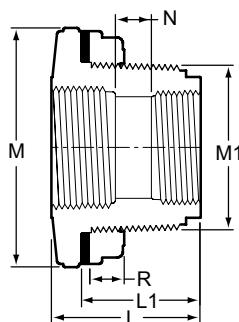

Part Number		Size	L	L1	M	M1	N	R	Approx. Wt. (Lbs.)	
PVC	CPVC								PVC	CPVC
872-005	872-005C	1/2	2-27/32	2-11/32	2-9/32	1-9/32	1-13/32	5/8	.24	.26
872-007	872-007C	3/4	2-23/32	2-1/4	2-1/2	1-5/8	1-5/32	5/8	.31	.32
872-010	872-010C	1	2-25/32	2-5/16	2-13/16	1-7/8	25/32	5/8	.36	.38
872-012	872-012C	1-1/4	3-1/8	2-5/8	3-27/32	2-11/32	1-1/8	5/8	.67	.65
872-015	872-015C	1-1/2	3-1/8	2-5/8	3-29/32	2-11/32	1-1/16	5/8	.58	.61
872-020	872-020C	2	3-5/32	2-3/8	5-1/16	3-7/16	1-5/32	3/4	1.35	1.42

PVC & CPVC SCHEDULE 80 FITTINGS, UNIONS, TANK ADAPTERS, EXPANSION JOINTS & SADDLES

OLD STYLE - TANK ADAPTER

Fipt x Fipt

Applicable to 872E-XXX

(continued)

150 psi @ 73°F

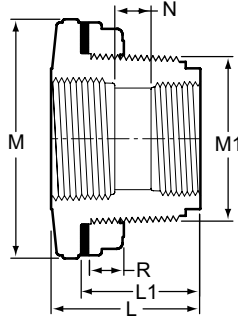

Part Number		Size	L	L1	M	M1	N	R	Approx. Wt. (Lbs.)	
PVC	CPVC								PVC	CPVC
872-030	872-030C	3	4-19/32	3-13/16	6-7/16	4-15/32	1-11/32	1-3/16	2.56	2.61
872-040	872-040C	4	4-7/16	3-1/2	7-1/2	5-1/2	15/16	1-1/4	3.34	3.47
872-060	872-060C	6	4-31/32	4-3/16	9-7/8	7-31/32	1-3/32	1-1/4	5.94	6.22

TANK ADAPTER GASKET SECTION	SIZE	OD*	ID*	T	Old Style Tank Adapter Gasket & Hole Size Requirements			
					Tank Adapter Size	Recommended Minimum Hole Size	Minimum Inside Curvature Radius (inches)	Maximum Tank Wall Thickness (inches)
	1/2	2.25	1.33	3/16	1/2	1-3/8	3.88	1.06
	3/4	2.49	1.69	3/16	3/4	1-3/4	5.00	1.06
	1	2.79	1.94	3/16	1	2	6.12	1.06
	1-1/4	3.81	2.39	3/16	1-1/4	2-7/16	10.75	1.34
	1-1/2	3.81	2.39	3/16	1-1/2	2-7/16	10.75	1.34
	2	4.89	3.51	3/16	2	3-9/16	18.50	1.16
	3	6.30	4.49	3/16	3	4-9/16	31.00	1.75
	4	7.33	5.50	3/16	4	5-9/16	42.75	1.81
	6	9.85	7.95	3/16	6	8	79.75	2.06

* Both outside and inside dimensions are +/- .03 shore hardness 65-70

PVC & CPVC SCHEDULE 80 FITTINGS, UNIONS, TANK ADAPTERS, EXPANSION JOINTS & SADDLES

SELF ALIGNING TANK ADAPTER

Fipt

Applicable to 8172ESA-XXX & 8172VSA-XXX

75 psi @ 73°F

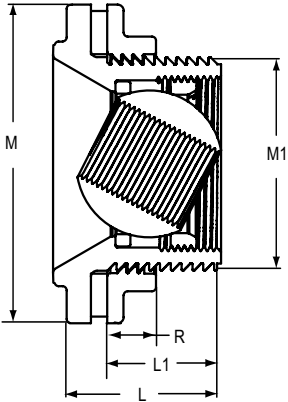

Part Number		Size	L	L1	M	M1	R	Approx. Wt. (Lbs.)	
PVC	CPVC							PVC	CPVC
8172SA-010	8172SA-010C	1	2-9/16	1-3/4	4-7/8	3-1/4	3/4	1.11	1.23
8172SA-020	8172SA-020C	2	2-11/16	1-3/4	6	4-9/16	1	1.99	2.09
8172SA-030	8172SA-030C	3	3-1/4	2-1/4	7-1/2	5-1/2	1-1/4	2.61	2.97

PVC & CPVC SCHEDULE 80 FITTINGS, UNIONS, TANK ADAPTERS, EXPANSION JOINTS & SADDLES

FABRICATED EXPANSION JOINTS WITH 6" & 12" TRAVEL

Soc x Soc

1/2" - 2" 235 psi @ 73°F
2-1/2" & Up 150 psi @ 73°F

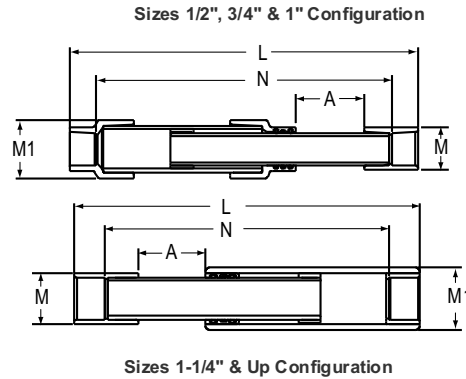

Part Number		Size	L	M	M1	N	Approx. Wt. (Lbs.)	
PVC	CPVC						PVC	CPVC
826-005x6	826-005x6C	1/2	13-11/16	1-9/32	1-23/32	11-15/16	.50	.55
826-007x6	826-007x6C	3/4	14-13/16	1-1/2	2-1/16	12-13/16	1.00	1.10
826-010x6	826-010x6C	1	15-15/16	1-23/32	2-11/32	13-11/16	1.00	1.10
826-012x6	826-012x6C	1-1/4	15-3/4	2-7/32	2-3/8	13-3/8	1.50	1.65
826-015x6	826-015x6C	1-1/2	16-1/8	2-11/32	2-7/8	13-7/16	2.00	2.20
826-020x6	826-020x6C	2	16-15/16	2-7/8	3-1/2	13-15/16	3.00	3.30
826-025x6	826-025x6C	2-1/2	18-7/8	4-3/16	4-1/2	14-7/8	6.00	6.60
826-030x6	826-030x6C	3	18-3/4	4-3/16	4-1/2	15-1/4	6.00	6.60
826-040x6	826-040x6C	4	19-3/4	5-5/16	5-9/16	15-3/16	7.00	7.70
826-060x6	826-060x6C	6	22-3/4	7-11/16	8-5/8	16-3/4	26.50	29.15
826-080x6	826-080x6C	8	27-1/4	9-11/16	10-3/4	19-1/4	40.50	44.55
826-100x6	826-100x6C	10	35-7/8	11-13/16	12-3/4	25-7/8	67.00	73.70
826-120x6	826-120x6C	12	39-1/2	14-1/8	16	27-1/2	134.00	147.40
826-140x6	---	14	49-3/4	15-5/8	16	34-7/8	104.27	---

Part Number		Size	L	M	M1	N	Approx. Wt. (Lbs.)	
PVC	CPVC						PVC	CPVC
826-005x12	826-005x12C	1/2	16-11/16	1-9/32	1-23/32	14-15/16	.57	.63
826-007x12	826-007x12C	3/4	17-13/16	1-1/2	2-1/16	15-13/16	1.14	1.26
826-010x12	826-010x12C	1	18-15/16	1-23/32	2-11/32	16-11/16	1.14	1.26
826-012x12	826-012x12C	1-1/4	18-3/4	2-7/32	2-3/8	16-3/8	1.71	1.88
826-015x12	826-015x12C	1-1/2	19-1/8	2-11/32	2-7/8	16-7/16	2.28	2.51
826-020x12	826-020x12C	2	19-15/16	2-7/8	3-1/2	16-15/16	3.43	3.77
826-025x12	826-025x12C	2-1/2	21-7/8	4-3/16	4-1/2	17-7/8	6.85	7.54
826-030x12	826-030x12C	3	21-3/4	4-3/16	4-1/2	18-1/4	6.85	7.54
826-040x12	826-040x12C	4	22-3/4	5-5/16	5-9/16	18-3/16	8.00	8.80
826-060x12	826-060x12C	6	25-3/4	7-11/16	8-5/8	19-3/4	30.27	33.30
826-080x12	826-080x12C	8	30-1/4	9-11/16	10-3/4	22-1/4	46.26	50.89
826-100x12	826-100x12C	10	38-7/8	11-13/16	12-3/4	28-7/8	76.53	84.19
826-120x12	826-120x12C	12	42-1/2	14-1/8	16	30-1/2	153.07	141.22
826-140x12	---	14	52-3/4	15-5/8	16	37-7/8	159.00	---

PVC & CPVC SCHEDULE 80 FITTINGS, UNIONS, TANK ADAPTERS, EXPANSION JOINTS & SADDLES

ELASTOMER EXPANSION JOINT WITH NEOPRENE BELLOWS

Soc x Soc

235 psi @ 73°F

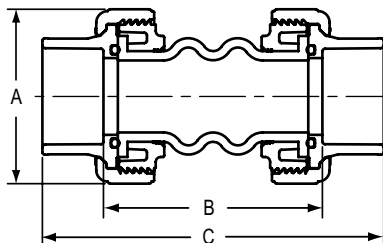

Part Number		Size	A	B	C	MAXIMUM MOVEMENTS				Approx. Wt. (Lbs.)	
PVC	CPVC					COMPRESSION	EXTENSION	LATERAL	ANGULAR	PVC	CPVC
EJ02-007	---	3/4	2-1/4	6-3/8	8-3/8	7/8	1/4	7/8	35°	.50	---
EJ02-010	---	1	2-9/16	5-15/16	8-3/16	7/8	1/4	7/8	25°	.71	---
EJ02-012	---	1-1/4	3-1/8	6-1/16	8-9/16	7/8	1/4	7/8	25°	.70	---
EJ02-015	---	1-1/2	3-9/16	5-7/8	8-5/8	7/8	1/4	7/8	20°	1.07	---
EJ02-020	---	2	4-3/16	5-7/16	8-7/16	7/8	1/4	7/8	15°	1.54	---
EJ20-025	---	2-1/2	6-1/8	6-3/16	9-3/4	7/8	1/4	7/8	15°	4.49	---
EJ02-030	---	3	6-1/8	6-3/16	10	7/8	1/4	7/8	15°	4.71	---

ELASTOMER EXPANSION JOINT WITH EPDM BELLOWS

Soc x Soc

235 psi @ 73°F

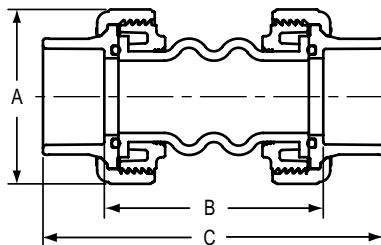

Part Number		Size	A	B	C	MAXIMUM MOVEMENTS				Approx. Wt. (Lbs.)	
PVC	CPVC					COMPRESSION	EXTENSION	LATERAL	ANGULAR	PVC	CPVC
EJ22-007	EJ22-007C	3/4	2-1/4	6-3/8	8-3/8	7/8	1/4	7/8	35°	.32	.39
EJ22-010	EJ22-010C	1	2-9/16	5-15/16	8-3/16	7/8	1/4	7/8	25°	.70	.81
EJ22-012	EJ22-012C	1-1/4	3-1/8	6-1/16	8-9/16	7/8	1/4	7/8	25°	.81	.84
EJ22-015	EJ22-015C	1-1/2	3-9/16	5-7/8	8-5/8	7/8	1/4	7/8	20°	1.03	1.07
EJ22-020	EJ22-020C	2	4-3/16	5-7/16	8-7/16	7/8	1/4	7/8	15°	1.54	1.61
EJ22-025	EJ22-025C	2-1/2	6-1/8	6-3/16	9-3/4	7/8	1/4	7/8	15°	4.49	4.77
EJ22-030	EJ22-030C	3	6-1/8	6-3/16	10	7/8	1/4	7/8	15°	4.81	5.04

PVC & CPVC SCHEDULE 80 FITTINGS, UNIONS, TANK ADAPTERS, EXPANSION JOINTS & SADDLES

ELASTOMER EXPANSION JOINT WITH NEOPRENE BELLOWS

SR Fipt x SR Fipt

235 psi @ 73°F

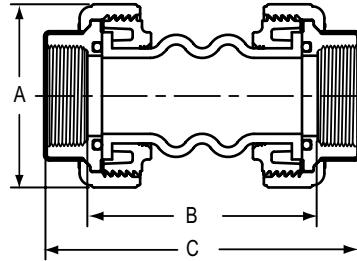

Part Number		Size	A	B	C	MAXIMUM MOVEMENTS				Approx. Wt. (Lbs.)	
PVC	CPVC					COMPRESSION	EXTENSION	LATERAL	ANGULAR	PVC	CPVC
EJ01-007SR	---	3/4	2-1/4	6-3/8	7-3/16	7/8	1/4	7/8	35°	.51	---
EJ01-010SR	---	1	2-9/16	6	7-3/4	7/8	1/4	7/8	25°	.73	---
EJ01-012SR	---	1-1/4	3-1/8	6-1/16	7-15/16	7/8	1/4	7/8	25°	.73	---
EJ01-015SR	---	1-1/2	3-9/16	5-7/8	7-3/4	7/8	1/4	7/8	20°	1.15	---
EJ01-020SR	---	2	4-3/16	5-7/16	7-3/8	7/8	1/4	7/8	15°	1.58	---
EJ01-025SR	---	2-1/2	6-1/8	6-3/16	9	7/8	1/4	7/8	15°	4.63	---
EJ01-030SR	---	3	6-1/8	6-3/16	9	7/8	1/4	7/8	15°	4.84	---

ELASTOMER EXPANSION JOINT WITH EPDM BELLOWS

SR Fipt x SR Fipt

235 psi @ 73°F

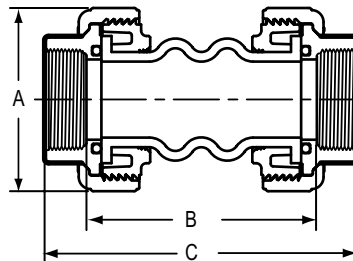

Part Number		Size	A	B	C	MAXIMUM MOVEMENTS				Approx. Wt. (Lbs.)	
PVC	CPVC					COMPRESSION	EXTENSION	LATERAL	ANGULAR	PVC	CPVC
EJ21-007SR	EJ21-007CSR	3/4	2-1/4	6-3/8	7-3/16	7/8	1/4	7/8	35°	.33	.39
EJ21-010SR	EJ21-010CSR	1	2-9/16	6	7-3/4	7/8	1/4	7/8	25°	.71	.83
EJ21-012SR	EJ21-012CSR	1-1/4	3-1/8	6-1/16	7-15/16	7/8	1/4	7/8	25°	.74	.76
EJ21-015SR	EJ21-015CSR	1-1/2	3-9/16	5-7/8	7-3/4	7/8	1/4	7/8	20°	1.15	1.19
EJ21-020SR	EJ21-020CSR	2	4-3/16	5-7/16	7-3/8	7/8	1/4	7/8	15°	1.58	1.65
EJ21-025SR	EJ21-025CSR	2-1/2	6-1/8	6-3/16	9	7/8	1/4	7/8	15°	4.63	4.91
EJ21-030SR	EJ21-030CSR	3	6-1/8	6-3/16	9	7/8	1/4	7/8	15°	4.85	5.19